

OPERATING MANUAL

Heating Circulators

HE-4

SE-6

SE-12

SE-26

Bridge Mounted Circulator

SE-Z

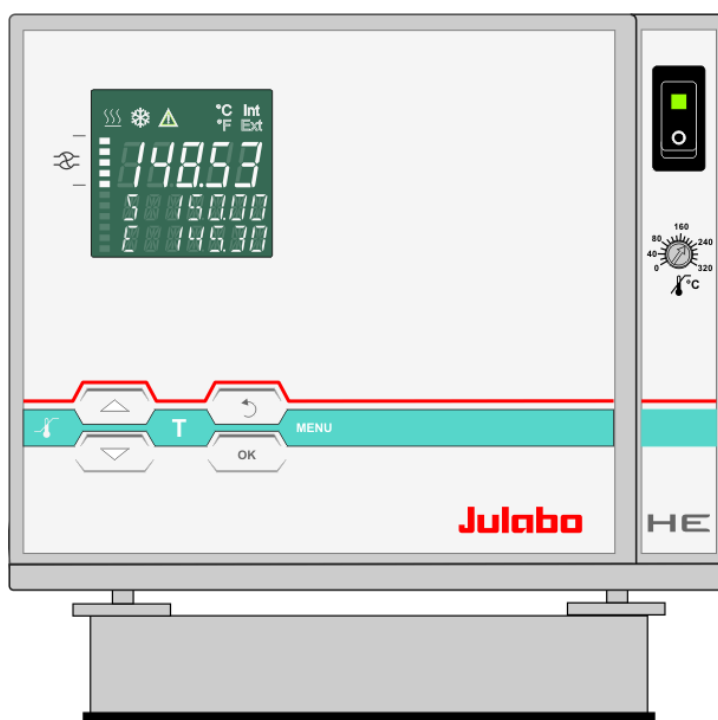

Julabo
THE TEMPERATURE CONTROL COMPANY

JULABO GmbH
77960 Seelbach / Germany
Tel. +49 (0) 7823 / 51-0
Fax +49 (0) 7823 / 24 91
info@julabo.de
www.julabo.de

Congratulations!

You have made an excellent choice.

JULABO thanks you for the trust you have placed in us.

This operating manual has been designed to help you gain an understanding of the operation and possible applications of our circulators. For optimal utilization of all functions, we recommend that you thoroughly study this manual prior to beginning operation.

The JULABO Quality Management System



Temperature control devices for research and industry are developed, produced, and distributed according to the requirements of ISO 9001 and ISO 14001. Certificate Registration No. 01 100044846

Unpacking and inspecting





Unpack the circulator and accessories and inspect them for possible transport damage. Damage should be reported to the responsible carrier, railway, or postal authority, and a damage report should be requested. These instructions must be followed fully for us to guarantee our full support of your claim for protecting against loss from concealed damage. The form required for filing such a claim will be provided by the carrier.

Printed in Germany

Changes without prior notification reserved

Important: keep operating manual for future use

TABLE OF CONTENTS

Operating manual.....	5
1. Intended use.....	5
1.1. Description.....	5
2. Operator responsibility – Safety recommendations.....	6
2.1. Disposal.....	7
2.2. EC Conformity.....	8
2.3. Warranty conditions.....	9
2.4. Technical specifications.....	10
Operating instructions.....	12
3. Safety notes for the user.....	12
3.1. Explanation of safety notes.....	12
3.2. Explanation of other notes.....	12
3.3. Safety recommendations.....	13
4. Operating controls and functional elements.....	15
5. Preparations.....	18
5.1. Installation.....	18
5.2. Bath fluids.....	19
5.3. Temperature application to external systems.....	20
5.3.1. Tubing.....	21
5.4. Filling / draining.....	22
5.5. Countercooling.....	23
6. Operating procedures.....	24
6.1. Power connection.....	24
6.2. Switching on / Start - Stop.....	24
6.2.1. Switching on the circulator.....	24
7.  Setting of temperatures.....	25
7.1. Using the pre-settings in the  menu.....	25
7.2. Direct setting of temperatures.....	26
8.  Safety installations, warning functions.....	27
8.1. Excess temperature protection.....	27
8.1.1. Early warning system, low level protection.....	28
8.2. Switch-over from warning to shutdown function.....	29
8.3. Over and Sub temperature warning function.....	30
9.  Menu functions.....	31
9.1. MENU PROGRAM – START.....	32
9.2. MENU PROGRAM – creation, administration.....	35

9.3. MENU PUMP - Setting of pump pressure	37
9.4. MENU CONFIG - Configuration of unit.....	38
9.4.1.Remote control via the serial interface.....	39
9.4.2.Keypad control or setpoint setting via the analog input	40
9.4.3.AUTOSTART.....	40
9.4.4.OFF-MODE	41
9.4.5.ACTVAR - actuating variable	41
9.4.6.Setting of clock and date	42
9.4.7.RESET – Factory settings.....	42
9.5. MENU CONTROL – Control characteristics and parameters.....	42
9.5.1.CONTROL – Control INTERNAL / EXTERNAL.....	44
9.5.2.SELFTUNING.....	45
9.5.3.Dynamic internal.....	45
9.5.4.Control parameters– XP-, TN-, TV- INTERNAL	46
9.5.5.COSPEED - external	47
9.5.6.Control parameters – XPU-, XP-, TN-, TV- EXTERNAL.....	47
9.6. MENU SERIAL - BAUDRATE, HANDSHAKE, PARITY	48
9.7. MENU ATC - Absolut Temperature Calibration	49
9.7.1.ATC SENSOR - INTERNAL / EXTERNAL.....	51
9.7.2.ATC STATUS - YES / NO.....	51
9.7.3.CALIBRATION TYPE: 1 -/ 2 -/ 3 POINT.....	52
9.7.4.Example: 3-point calibration for internal control	53
9.8. MENU LIMITS - Begrenzungen.....	55
9.8.1.Limits for internal control.....	56
9.8.2.Limits for external control.....	56
9.9. MENU IN/OUT – Analog inputs/outputs (Option).....	58
9.9.1.Outputs of the connector - REG+E-PROG.....	61
9.9.2.Input of the connector - REG+E-PROG	62
9.9.3.ALARM-output / Stand-by-input.....	64
10. Troubleshooting guide / error messages.....	66
11. Electrical connections.....	69
12. Remote control.....	71
12.1. Setup for remote control.....	71
12.2. Communication with a PC or a superordinated data system	71
12.3. List of commands.....	72
12.4. Status messages	75
12.5. Error messages.....	75
13. Installation of electronic module.....	76
14. JULABO Service – Online remote diagnosis.....	77
15. Cleaning / repairing the unit.....	78

Operating manual

1. Intended use

JULABO circulators have been designed to control the temperature of specific fluids in a bath tank. The units feature pump connections for temperature control of external systems (loop circuit).



JULABO circulators are not suitable for direct temperature control of foods, semi-luxury foods and tobacco, or pharmaceutical and medical products. Direct temperature control means unprotected contact of the object with the bath medium (bath fluid).

1.1. Description

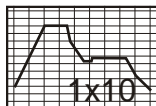
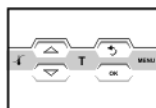
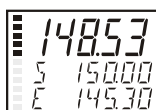

ICC

TCF

ATC³

RS232

Pt100

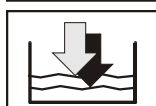
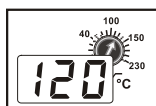

SMART PUMP

- ☑ The circulators are operated via the splash-proof keypad. The implemented microprocessor technology allows to set and to store different values that can be indicated on the VFD COMFORT-DISPLAY. Three menu keys facilitate adjusting setpoints, warning and safety functions and menu functions.
- ☑ Temperature- and time-dependent processes can be stored and executed using the integrated programmer.
- ☑ The control electronics including “ICC - Intelligent Cascade Control” automatically adjust the heat supply to the thermal requirements of the bath.
- ☑ The TCF - **T**emperature **C**ontrol **F**eatures give the user access to all important temperature control parameters. This means full control of the control behavior at all times and the ability to manually adjust or adapt the controls to the specific application.
- ☑ Absolute Temperature Calibration (ATC3) provides high temperature stability at all points in the bath. With the 3-point calibration, an offset is adjusted at three temperatures to ensure an accurate temperature pattern at the selected spot in the bath over the entire temperature range.
- ☑ Electrical connections:
The serial interface, switchable from RS232 to RS485, allows modern process technology without additional interface.
Connection for Pt100 external sensor for external temperature measurement and control.
Alarm output for external alarm message or control of JULABO refrigerating baths or solenoid valve (cooling water).
The electronic module (option) provides 3 further analog connections (alarm input, standby input, recorder output, programmer input).
- ☑ The excess temperature protection conforming to IEC 61010-2-010 is a safety installation independent from the control circuit. This protection can be indicated and set on the VFD COMFORT-DISPLAY.
- ☑ The early warning system for low level signals that bath fluid needs to be refilled before the low level protection conforming to IEC 61010-2-010 causes a complete shutdown of the main functional elements.
- ☑ Intelligent pump system: The pump capacity (electronically adjustable via the motor speed) enables to adapt to varying conditions for internal and external temperature applications.

2. Operator responsibility – Safety recommendations

The products of JULABO ensure safe operation when installed, operated, and maintained according to common safety regulations. This section explains the potential dangers that may arise when operating the circulator and also specifies the most important safety precautions to preclude these dangers as far as possible.

- The operator is responsible for the qualification of the personnel operating the units.
- The personnel operating the units should be regularly instructed about the dangers involved with their job activities as well as measures to avert these dangers.
- Make sure all persons tasked with operating, installing, and maintaining the unit have read and understand the safety information and operating instructions.
- When using hazardous materials or materials that could become hazardous, the circulator may be operated only by persons who are absolutely familiar with these materials and the circulator. These persons must be fully aware of possible risks.

If you have any questions concerning the operation of your unit or the information in this manual, please contact us!

Contact JULABO GmbH
Eisenbahnstraße 45
77960 Seelbach / Germany

Tel. +49 (0) 7823 / 51-0
Fax +49 (0) 7823 / 24 91
info@julabo.de
www.julabo.de

Safety instructions for the operator:

- You have received a product designed for industrial use. Nevertheless, avoid strikes to the housing, vibrations, damage to the operating-element panel (keypad, display), and contamination.
- Make sure the product is checked for proper condition regularly (depending on the conditions of use). Regularly check (at least every 2 years) the proper condition of the mandatory, warning, prohibition and safety labels.
- Make sure that the mains power supply has low impedance to avoid any negative effects on instruments being operated on the same mains.
- This unit is designed for operation in a controlled electromagnetic environment. This means that transmitting devices (e.g., cellular phones) should not be used in the immediate vicinity. Magnetic radiation may affect other devices with components sensitive to magnetic fields (e.g., monitors). We recommend maintaining a minimum distance of 1 m.
- Permissible ambient temperature: max. 40 °C, min. 5 °C.
- Permissible relative humidity: 50% (40 °C).
- Do not store the unit in an aggressive atmosphere.
- Protect the unit from contamination.
- Do not expose the unit to sunlight.

Appropriate operation

Only qualified personnel is authorized to perform configuration, installation, maintenance and repairs of the circulator.

Routine operation can also be carried out by untrained personnel who should however be instructed by trained personnel.

Use:

The bath can be filled with flammable materials. Fire hazard!



There might be chemical dangers depending on the bath medium used.

Observe all warnings for the used materials (bath fluids) and the respective instructions (safety data sheets).

Insufficient ventilation may result in the formation of explosive mixtures. Only use the unit in well ventilated areas.

Only use recommended materials (bath fluids). Only use non-acid and non corroding materials.

When using hazardous materials or materials that could become hazardous, **the operator must** affix the enclosed safety labels (**1 + 2**) to the front of the unit so they are highly visible:

1		Warning label W00: Colors: yellow, black Danger area. Attention! Observe instructions. (operating manual, safety data sheet)
2		Mandatory label M018: Colors: blue, white Carefully read the user information prior to beginning operation. Scope: EU
or		
2		Semi S1-0701 Table A1-2 #9 Carefully read the user information prior to beginning operation. Scope: USA, NAFTA

Particular care and attention is necessary because of the wide operating range.

There are thermal dangers: Burn, scald, hot steam, hot parts and surfaces that can be touched.

	Warning label W26: Colors: yellow, black Hot surface warning. (The label is put on by JULABO)
---	---

Observe the instructions in the manuals for instruments of a different make that you connect to the circulator, particularly the respective safety recommendations. Also observe the pin assignment of plugs and technical specifications of the products.

2.1. Disposal

The circulator contains a back-up battery that supplies voltage to memory chips when the unit is switched off. Do not dispose of the battery with household waste!

Depending on battery regulations in your country, you might be obliged to give back used or defect batteries to gathering places.

The product may be used with oil as bath fluid. These oils fully or partially consist of mineral oil or synthetic oil. For disposal, observe the instructions in the safety data sheets.



Valid in EU countries

See the current official journal of the European Union – WEEE directive.

Directive of the European Parliament and of the Council on waste electrical and electronic equipment (WEEE).

This directive requires electrical and electronic equipment marked with a crossed-out trash can to be disposed of separately in an environmentally friendly manner.

Contact an authorized waste management company in your country.

Disposal with household waste (unsorted waste) or similar collections of municipal waste is not permitted!

2.2. EC Conformity

EG-Konformitätserklärung nach EG Maschinenrichtlinie 2006/42/EG, Anhang II A EC-Declaration of Conformity to EC Machinery Directive 2006/42/EC, Annex II A

Hersteller / Manufacturer:

JULABO GmbH
Eisenbahnstr. 45
77960 Seelbach / Germany
Tel: +49(0)7823 / 51 - 0



Hiermit erklären wir, dass das nachfolgend bezeichnete Produkt
We hereby declare, that the following product

Produkt / Product: Thermostat / Circulator

Typ / Type: HE, HL, SE, SL

Serien-Nr. / Serial-No.: siehe Typenschild / see type label

aufgrund seiner Konzipierung und Bauart in der von uns in Verkehr gebrachten Ausführung den grundlegenden Sicherheits- und Gesundheitsanforderungen den nachfolgend aufgeführten EG-Richtlinien entspricht.

due to the design and construction, as assembled and marketed by our Company – complies with fundamental safety and health requirements according to the following EC-Directives.

Maschinenrichtlinie 2006/42/EG; Machinery Directive 2006/42/EC

EMV-Richtlinie 2004/108/EG; EMC-Directive 2004/108/EC

RoHS-Richtlinie 2011/65/EU; RoHS-Directive 2011/65/EU

Angewandte harmonisierte Normen und techn. Spezifikationen:

The above-named product is in compliance with the following harmonized standards and technical specifications:

EN ISO 12100 : 2010

Sicherheit von Maschinen - Allgemeine Gestaltungsleitsätze - Risikobeurteilung und Risikominderung (ISO 12100:2010)
Safety of machinery - General principles for design - Risk assessment and risk reduction (ISO 12100:2010)

EN 61010-1 : 2010

Sicherheitsbestimmungen für elektrische Mess-, Steuer-, Regel- und Laborgeräte, Teil 1: Allgemeine Anforderungen
Safety requirements for electrical equipment for measurement, control, and laboratory use, Part 1: General requirements

EN 61010-2-010 : 2003

Sicherheitsbestimmungen für elektrische Mess-, Steuer-, Regel- und Laborgeräte, Teil 2-010: Besondere Anforderungen an Laborgeräte für das Erhitzen von Stoffen
Safety requirements for electrical equipment for measurement, control, and laboratory use, Part 2-010: Particular requirements for laboratory equipment for the heating of materials

EN 61326-1 : 2006

Elektrische Mess-, Steuer-, Regel- und Laborgeräte- EMV-Anforderungen- Teil 1: Allgemeine Anforderungen
Electrical equipment for measurement, control, and laboratory use - EMC requirements - Part 1: General requirements

Bevollmächtigter für die Zusammenstellung der techn. Unterlagen:

Authorized representative in charge of administering technical documentation:

Hr. Torsten Kauschke, im Hause / on the manufacturer's premises as defined above

Die Konformitätserklärung wurde ausgestellt

The declaration of conformity was issued and valid of

Seelbach, 27.05.2013

M. Juchheim, Geschäftsführer / Managing Director

2.3. Warranty conditions

JULABO GmbH warrants its products against defects in material or in workmanship, when used under appropriate conditions and in accordance with appropriate operating instructions

for a period of ONE YEAR.

Extension of the warranty period – free of charge



With the '1PLUS warranty' the user receives a free of charge extension to the warranty of up to 24 months, limited to a maximum of 10 000 working hours.

To apply for this extended warranty the user must register the unit on the JULABO web site www.julabo.de, indicating the serial no. The extended warranty will apply from the date of JULABO GmbH's original invoice.

JULABO GmbH reserves the right to decide the validity of any warranty claim. In case of faults arising either due to faulty materials or workmanship, parts will be repaired or replaced free of charge, or a new replacement unit will be supplied.

Any other compensation claims are excluded from this guarantee.

2.4. Technical specifications

Heating circulators		HE-4	SE-6	SE-12	SE-26
Working temperature range	°C	20 ... 250	20 ... 300	20 ... 300	20 ... 300
Temperature stability	°C	±0.01	±0.01	±0.01	±0.01
Bath opening (WxL)	cm	13x15	13x15	22x15	22x30
Bath depth	cm	15	20	20	20
Filling volume	liters	3 ... 4,5	4,5 ... 6	7,5 ... 12	18 ... 26
Overall dimensions (WxDxH)	cm	21x42x40	21x43x44	30x43x47	36x61x47
Weight	kg	11	13,5	14,0	27,0

Bridge mounted circulator		SE-Z
Working temperature range	°C	20 ... 300
Temperature stability	°C	±0.01
Immersion depth max./min.	cm	18/9
Overall dimensions (WxDxH)	cm	32x17x33
Weight	kg	7

		HE	SE
Mains power connection	230 V/50-60 Hz	V/Hz	190-253 / 50-60
Current draw (at 208 V / 230 V)		A	8 / 9
Mains power connection	115 V/50-60 Hz	V/ Hz	90-127 / 50-60
Current draw (at 100 V / 115 V)		A	9 / 10

All measurements have been carried out at: rated voltage and frequency
 ambient temperature: 20 °C bath fluid: water operating temperature: 70 °C
 Technical changes without prior notification reserved.

		HE	SE
Temperature selection		digital	
via keypad		indication on VFD COMFORT-DISPLAY	
remote control via PC		indication on monitor	
Temperature indication		VFD COMFORT-DISPLAY	
Resolution	°C	0.01	0.01
ATC3	INT/EXT	°C	±3 / ±9
Temperature control		ICC - Intelligent Cascade Control	
Heater wattage (at 230 V)		kW	2,0
Heater wattage (at 115 V)		kW	---
Electronically adj. pump capacity	stages		1 ... 4
Flow rate at 0 bar		l/min	22 ... 26
Max. pressure at 0 liters		bar	0.7
Max. suction at 0 liters		bar	0.4
Electrical connections:		See page 11	
Ambient temperature	°C	5 ... 40	5 ... 40

Electrical connections:

External alarm device 24-0 V DC / max. 25 mA
 Computer interface RS232 or RS485
 External Pt100 sensor

Optional for HE, SE

(Order No. 8900100 Electronic module with analog connections)

Programmer input -100 °C to 400 °C = 0 - 10 V or 0 - 20 mA or 4 - 20 mA

Input for the signal of a flow meter or external manipulated variable

Temperature recorder outputs	0 - 10 V (0 V = -100 °C, 10 V = 400 °C)
	0 - 20 mA (0 mA = -100 °C, 20 mA = 400 °C)
	4 - 20 mA (4 mA = -100 °C, 20 mA = 400 °C)

Standby input	for external emergency switch-off
---------------	-----------------------------------

Alarm output	for external alarm signal
--------------	---------------------------

Safety installations according to IEC 61010-2-010:

Excess temperature protection	adjustable from 0 °C ... 320 °C
Low liquid level protection	float switch
Classification according to DIN 12876-1	class III

Supplementary safety installations

Early warning system for low level	float switch
High temperature warning function	optical + audible (in intervals)
Low temperature warning function	optical + audible (in intervals)
Supervision of working sensor	plausibility control
Reciprocal sensor monitoring between working and safety sensors	difference >35 K
Alarm message	optical + audible (permanent)
Warning message	optical + audible (in intervals)

Environmental conditions according to IEC 61 010-1:

Use indoors only.

Altitude up to 2000 m - normal zero.

Ambient temperature: see Technical specifications

Humidity:

Max. relative humidity 80% for temperatures up to +31 °C,

linear decrease down to 50% relative humidity at a temperature of +40 °C

Max. mains voltage fluctuations of $\pm 10\%$ are permissible.

Protection class according to IEC 60 529	IP21
--	------

The unit corresponds to Class I

Overtoltage category	II
----------------------	----

Pollution degree	2
------------------	---

**Caution:**

The unit is not suitable for use in explosive environment

EMC requirements according to EN 61326-1

This unit is an ISM device classified in Group 1 (using high frequency for internal purposes), Class A (industrial and commercial range).

Operating instructions

3. Safety notes for the user

3.1. Explanation of safety notes



In addition to the safety warnings listed, warnings are posted throughout the operating manual. These warnings are designated by an exclamation mark inside an equilateral triangle. "Warning of a dangerous situation (Attention! Please follow the documentation)."

The danger is classified using a signal word.

Read and follow these important instructions for averting dangers.



Warning:

Describes a **possibly** highly dangerous situation. If these instructions are not followed, serious injury and danger to life could result.



Caution:

Describes a **possibly** dangerous situation. If this is not avoided, slight or minor injuries could result. A warning of possible property damage may also be contained in the text.



Notice:

Describes a **possibly** harmful situation. If this is not avoided, the product or anything in its surroundings can be damaged.

3.2. Explanation of other notes



Note!

Draws attention to something special.



Important!

Indicates usage tips and other useful information.



This icon is used in the operating instructions to indicate flashing values or parameters which have to be set or confirmed.

3.3. Safety recommendations

Follow the safety instructions to avoid personal injury and property damage. Also, the valid safety instructions for workplaces must be followed.



- Only connect the unit to a power socket with an earthing contact (PE – protective earth)!
- The power supply plug serves as a safe disconnecting device from the line and must always be easily accessible.
- Place the unit on an even surface on a base made of nonflammable material.
- Do not stay in the area below the unit.
- Make sure you read and understand all instructions and safety precautions listed in this manual before installing or operating your unit.
- Set the excess temperature safety installation at least 25 °C below the fire point of the bath fluid.
- Observe the limited working temperature range when using plastic bath tanks.
- Never operate the unit without bath fluid in the bath.
- Pay attention to the thermal expansion of bath oil during heating to avoid overflowing of the fluid.
- Prevent water from entering the hot bath oil.
- Do not drain the bath fluid while it is hot!
Check the temperature of the bath fluid prior to draining (e.g., by switching the unit on for a short moment).
- Use suitable connecting tubing.
- Avoid sharp bends in the tubing, and maintain a sufficient distance from surrounding walls.
- Make sure that the tubing is securely attached.
- Regularly check the tubing for material defects (e.g., for cracks).
- Never operate damaged or leaking units.
- Always turn off the unit and disconnect the mains cable from the power source before performing any service or maintenance procedures, or before moving the unit.
- Always turn off the unit and disconnect the mains cable from the power source before cleaning the unit.
- Always empty the bath before moving the unit.
- Transport the unit with care.
- Sudden jolts or drops may cause damage in the interior of the unit.
- Observe all warning labels.
- Never remove warning labels.
- Never operate units with damaged mains power cables.
- Repairs are to be carried out only by qualified service personnel.



- Some parts of the bath tank and the pump connections may become extremely hot during continuous operation. Therefore, exercise particular caution when touching these parts.



Caution:

The temperature controlling i.e. of fluids in a reactor constitutes normal circulator practice.

We do not know which substances are contained within these vessels.

Many substances are:

- inflammable, easily ignited or explosive
- hazardous to health
- environmentally unsafe

i.e.: **dangerous**

The user alone is responsible for the handling of these substances!

The following questions shall help to recognize possible dangers and to reduce the risks to a minimum.

- Are all tubes and electrical cables connected and installed?
Note:
sharp edges, hot surfaces in operation, moving machine parts, etc.
- Do dangerous steams or gases arise when heating?
Is an exhaust needed when working?
- What to do when a dangerous substance was spilled on or in the unit?
Before starting to work, obtain information concerning the substance and determine the method of decontamination.



Notice:

Check the safety installations at least twice a year!

- Excess temperature protection according to IEC 61010-2-010.
With a screwdriver turn back the adjustable excess temperature protection until the shut-down point (actual temperature).
- Low level protection according to IEC 61010-2-010.
To check the function of the float, it can be manually lowered with a screwdriver for example.

4. Operating controls and functional elements

Front view

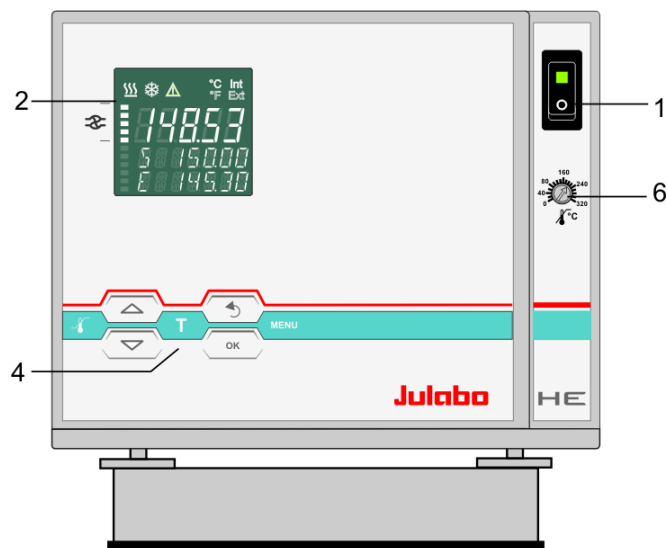

Rear view

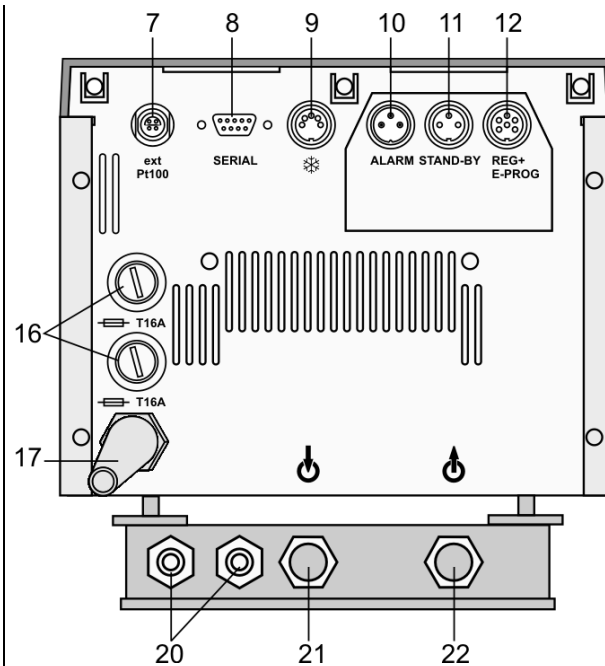

- 1  Mains power switch, illuminated

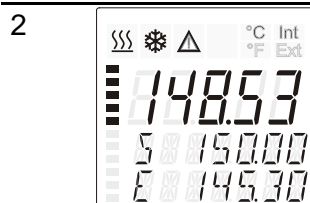

VFD COMFORT-DISPLAY

Header: Control indicators

- Line 1: Actual value internal or external
The display is depending on the selected control mode in the menu > Control < (internal or external).
- Line 2: Working temp. setpoint, constantly S xxx.xx
- Line 3: Actual value (E = external or I = internal)
Alternating with the display in line 1

Use the keys  to indicate further values in line 3

PI Capacity in % - with manipulated variable set to >control<*

PS Capacity in % - with manipulated variable set to >serial<* or >eprog<*

















H Heater capacity in Watts









U Mains voltage Volts

F Flow rate in liters/minute
(providing EPROG input set to >Flowrate<)

*refer to >MENU/CONFIG< → >CONFIG / ACTVAR>

Operating controls and functional elements

2.1		<u>Control indicators in the header:</u> Heating / Cooling / Alarm / R emote control
2.2		<u>Control indicators in the header:</u> Temperature indication I nternal or E xternal actual value Temperature indication in °C (°F not possible on this unit)
2.3		Display of set pump pressure stage Four stages, can be set via the key  , under >MENU - PUMP<.
4 Navigation keys		
4.1		1. Key: >OK< Start / Stop (pump / heater) 2. >OK< in the menu Menu item / select submenu for setting Save set value Save selected parameter A beep signals the end of setting
		After the actions Start, Stop and change from VFD Display to standard display the key  is locked for a short time. The above graph "front side" shows an example for standard display.
4.2		1. Key: >Return< Stop (pump / heater) 2. >Return< in the menu one menu level down Correction function for parameters or values (prior to OK)
		immediately back to standard display
		 -  icon for „keep key pressed down“.
4.3		1. Key: >Up / Down <temperature – increase/decrease setpoint Push key quickly for single steps, Keep key pressed for fast change. 2. >Up/Down< in the menu selection of menu items / parameters
Menu keys		
4.4		Key: start the menu > warning and safety values<
4.5		Key: start the menu >temperature setpoints<
4.6		Key: display of MENU structure
6		Adjustable excess temperature protection according to IEC 61010-2-010

7	 ext Pt100	Socket for external measurement and control sensor or external setpoint programming
8	 SERIAL	Interface RS232: remote control via personal computer
9		Socket: control cable of JULABO refrigerated circulator or output for alarm messages
Option: Electronic module Order No. 8 900 100		
10	 ALARM	Alarm output (for external alarm signal)
11	 STAND-BY	Standby input (for external emergency switch-off)
12	 REG+E-PROG	Programmer input and temperature recorder output
16		Mains fuses, T16A
17		Mains power cable with plug
20		Cooling coil connectors
21		Pump connectors  suction pump  pressure pump

5. Preparations

5.1. Installation

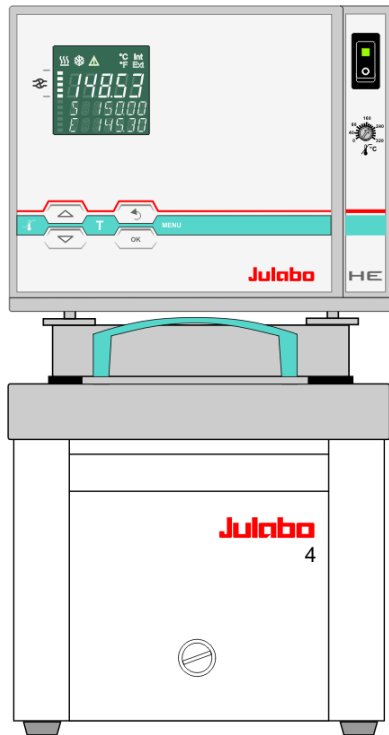

Heating circulators

- Place the unit on an even surface on a base made of **nonflammable** material.



Bridge mounted circulator SE-Z

- Place the bath tank in an upright position.

1. Remove screw on both sides (transportation safety device in the middle).
2. Extend the bridge and place it on the bath tank. The bridge is extendable from 310 mm to 660 mm.
3. Adjust the bridge to the width of the bath tank.

5.2. Bath fluids



Caution:

Carefully read the safety data sheet of the bath fluid used, particularly with regard to the fire point!

If a bath fluid with a fire point of ≤ 65 °C is used, only supervised operation is possible.

Water: The quality of water depends on local conditions.

- Due to the high concentration of lime, hard water is not suitable for temperature control because it leads to calcification in the bath.
- Ferrous water can cause corrosion - even on stainless steel.
- Chloric water can cause pitting corrosion.
- Distilled and deionized water is unsuitable. Their special properties cause corrosion in the bath, even in stainless steel.

Recommended bath fluids:

Bath fluid	Temperature range
soft/decalcified water	5 °C to 80 °C

JULABO bath fluids

JULABO Description		Thermal G	Thermal M	Thermal HS
Order Number	10 liters	8 940 124	8 940 100	8 940 102
	5 liters	8 940 125	8 940 101	8 940 103
Temperature range	°C	-30 ... 80	40 ... 170	20 ...250
Flash point	°C	--	284	270
Fire point	°C	--	306	>360
Color		light yellow	clear	light brown

JULABO Description		Thermal H10	Thermal H20S	Thermal H200
Order Number	10 liters	8 940 114	8 940 108	8 940 134
	5 liters	8 940 115	8 940 109	8 940 135
Temperature range	°C	-20 ... 180	0 ... 220	60 ...200
Flash point	°C	190	230	292
Fire point	°C	216	274	334
Color		clear	light brown	clear



See website for list of recommended bath fluids.

ATTENTION: The maximum permissible viscosity is 70 mm² /s.



Caution:

Fire or other dangers when using bath fluids that are not recommended:

Please contact JULABO before using other than recommended bath fluids.

Use only nonacidic and noncorrosive bath fluids.

JULABO assumes no liability for damage caused by the selection of an unsuitable bath liquid.

Unsuitable bath fluids are fluids which, e.g.,

- are highly viscous
(much higher than recommended at the respective working temperature)

- have a low viscosity and have creep characteristics
- have corrosive characteristics or
- tend to crack.
- **No liability for use of other bath fluids!**

5.3. Temperature application to external systems



Caution: Securely attach all tubing to prevent slipping.

If the circulator is operated without external system, close the pump connector (22) with the cap nut.

Temperature application to external, closed systems

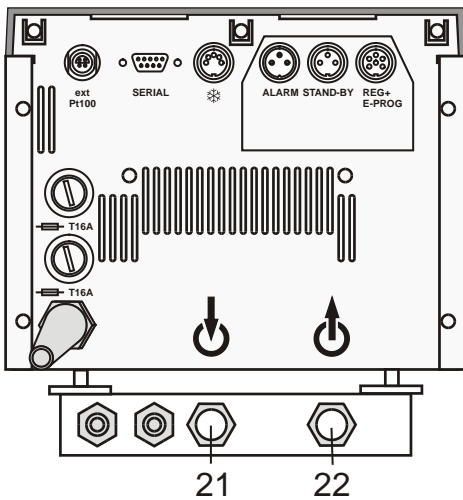

The circulator is used for temperature application to external, closed systems (loop circuit) with simultaneous temperature application in the circulator bath.

- Unscrew the M16x1 collar nuts on the pump connectors with a 19 mm (3/4") wrench and remove the sealing disks. Using the collar nuts, screw on the tubing connection fittings (for tubing 8 mm or 12 mm in diameter) delivered with the unit and tighten firmly. (Pressure pump: 22, suction pump: 21)
- Push on the tubings, and secure with tube clamps.
- Attach the tubings to the connectors of the external closed system, e.g., an instrument with a pressure-resistant temperature jacket or a temperature coil, and fasten with tube clamps to prevent slipping.

Temperature application to external, open systems

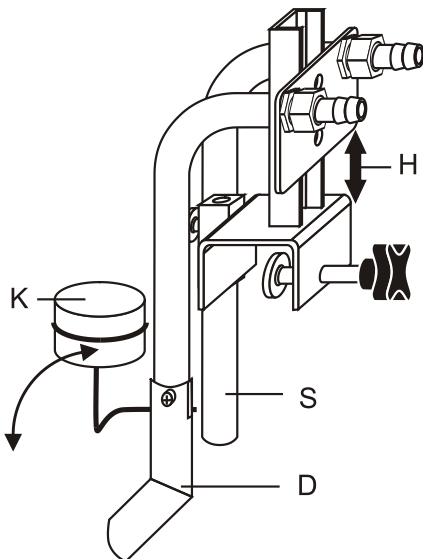

S = Suction pump connection
 D = Pressure pump connection
 K = Float
 H = Height adjustment

The circulator is equipped with both a pressure and suction pump for external temperature application in open systems.

Differing flow rates of the pressure and suction pumps should be compensated. To maintain a constant liquid level, the JULABO „D+S“ Level Adapter is recommended for the external bath tank. The flow rate of the pressure pump will be then regulated by a built-in float device. The liquid level may be changed by a height adjustment on the „D+S“ Level Adapter.

Accessory: „D+S“ Level Adapter Order No. 8 970 410

Important:

- ① The liquid level should be equal in the internal and external baths (absolute height).
- ① If you take out samples (for example Erlenmeyer flasks) from the external bath, turn the circulator off with the Start/Stop key.

Return flow safety device

If the liquid levels in the circulator bath and the external system are at different heights, overflowing must be prevented after the power has been turned off.



Flood hazard!

For this reason, shut-off valves can be integrated in the loop circuit.

Order No.	Description
8 970 456	Shut-off valve (suitable up to +90 °C)
8 970 457	Shut-off valve (suitable up to +200 °C)

5.3.1. Tubing

Recommended tubing:

Order No.	Length		Temperature range
8930008	1 m	CR [®] tubing 8 mm inner dia.	-20 °C to 120 °C
8930012	1 m	CR [®] tubing 12 mm inner dia.	-20 °C to 120 °C
8930108	1 m	Viton tubing 8 mm inner dia.	-50 °C to 200 °C
8930112	1 m	Viton tubing 12 mm inner dia.	-50 °C to 200 °C
8930410	1 m	Insulation for tubing 8 mm inner dia.	-50 °C to 100 °C
8930412	1 m	Insulation for tubing 12 mm inner dia.	-50 °C to 100 °C
8 930 209	0.5 m	Metal tubing, triple insulated, M16x1	-100 °C to +350 °C
8 930 210	1.0 m		
8 930 211	1.5 m		
8 930 214	3.0 m		
8 930 220	0.5 m	Metal tubing, insulated, M16x1	-50 °C to +200 °C
8 930 221	1.0 m		
8 930 222	1.5 m		
8 930 223	3.0 m		



Warning: Tubing:

At high working temperatures the tubing used for temperature application and cooling water supply represents a danger source.

A damaged tubing line may cause hot bath fluid to be pumped out within a short time.

This may result in:

- Burning of skin
- Difficulties in breathing due to hot atmosphere

Safety recommendations

- Employ suitable connecting tubing.
- Make sure that the tubing is securely attached.
- Avoid sharp bends in the tubing, and maintain a sufficient distance from surrounding walls.
- Regularly check the tubing for material defects (e.g. for cracks).
- Preventive maintenance: Replace the tubing from time to time.

5.4. Filling / draining



Notice:

- Pay attention to the thermal expansion of bath oil during heating to avoid overflowing of the liquid.
- Do not drain the bath fluid while it is hot!
Recommendation: Temperature range 5 °C to 40 °C
Check the temperature of the bath fluid prior to draining (by switching the unit on for a short moment, for example).
- Store and dispose the used bath fluid according to the laws for environmental protection.

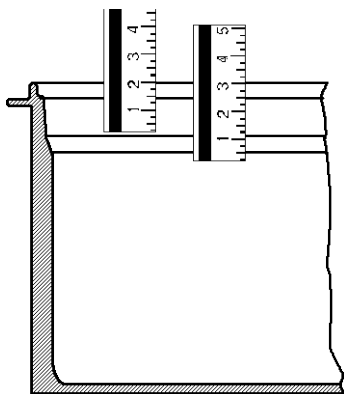

Filling

Take care that no liquid enters the interior of the circulator.

- Recommended maximum filling level with water as bath fluid: 30 mm below the tank rim
 - Recommended maximum filling level with bath oils: 40 mm below the tank rim
- ⓘ After filling, immerse the samples in the bath or place the lid on the bath, in case the opening is not to be used.
- ⓘ The circulator provides an early warning system for low level (description – please refer to page 28) that may be triggered when changing samples in the bath.

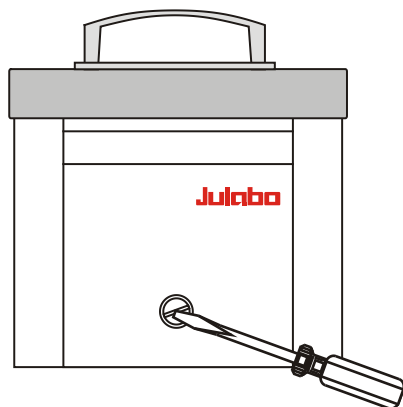

Draining

- Turn the unit off with the mains switch.
- Place the heating circulator near the rim of the table. Use a suitable vessel as recipient for the bath fluid.
- Unscrew the drain plug on the front of the bath tank to drain the bath.

5.5. Countercooling



Caution:
Securely attach all tubing to prevent slipping.

Observe the laws and regulations of the water distribution company valid in the location where the unit is operated.

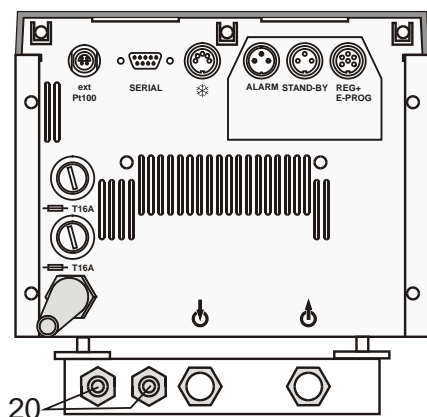

For applications near the ambient temperature, the cooling coil (20) must be connected to the water mains.

- Using tubing, connect the cooling coil to the tap water supply, and lead the tap water in a sink through the return connector.
- ❗ A specific water flow rate of 750 ml/minute (15 °C) is sufficient to compensate for the characteristic temperature.
- ❗ For applications near ambient temperature (20 °C), the cooling water temperature should at least be 5 °C below the working temperature.

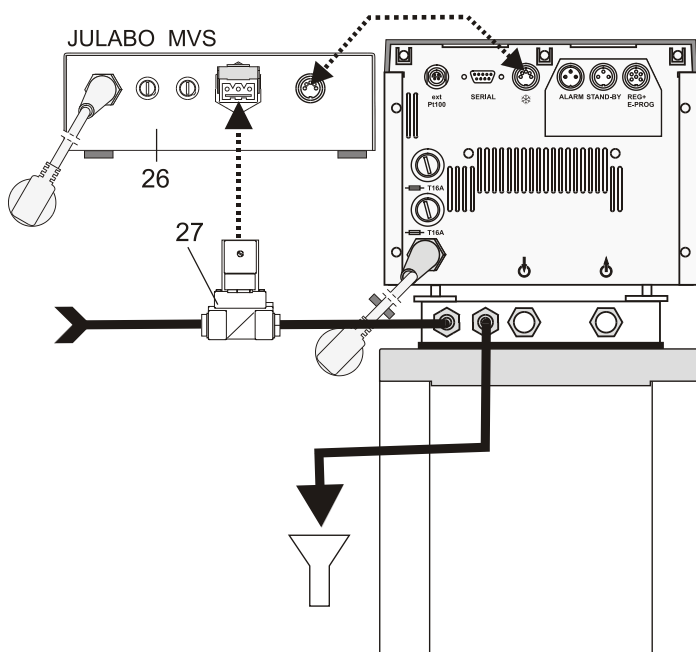

- ❗ **Controlled countercooling**
Use the MVS solenoid valve controller (26) and a solenoid valve (27) for controlled countercooling to reduce tap water consumption.
- ❗ The circulator recognizes the MVS controller via the socket ❄️ (10) and automatically adjusts the necessary parameters.

Accessory:

Order No.	Description
9 790 000	MVS controller for cooling water
8 980 700	Solenoid valve for cooling water



FD200 Flow-through cooler
Order No. 9 655 825

The FD200 is suitable as cooling device for liquids in closed circuits (loops).

This unit is integrated in the return flow circuit from the external system connected to a circulator, and continuously withdraws heat from the liquid.

6. Operating procedures

6.1. Power connection



Caution:

- Only connect the unit to a power socket with earthing contact (PE – protective earth)!
- The power supply plug serves as safe disconnecting device from the line and must be always easily accessible.
- Never operate equipment with damaged mains power cables.
- Regularly check the mains power cables for material defects (e.g. for cracks).
- We disclaim all liability for damage caused by incorrect line voltages!

Check to make sure that the line voltage matches the supply voltage specified on the identification plate. Deviations of $\pm 10\%$ are permissible.

6.2. Switching on / Start - Stop

6.2.1. Switching on the circulator

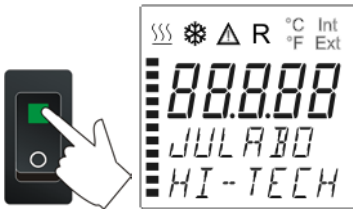

Switching on:

- Turn on the mains power switch (1).

i The unit performs a self-test. Then the software version (example: V 1.xx) appears. The display „OFF“ or „R OFF“ indicates the unit is ready to operate.

i The circulator enters the operating mode activated before switching the circulator off:

keypad control mode (manual operation)

or

remote control mode (operation via personal computer).

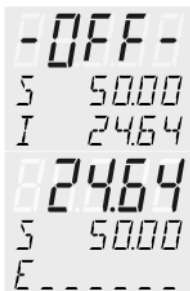
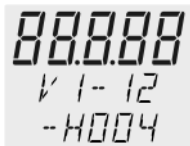

Start:

- Press **OK** key. The actual bath temperature is displayed on the VFD COMFORT-DISPLAY. The circulating pump starts with a slight delay.

Stop:

- i** Press **OK** key.

or

Keep key pressed.

The VFD COMFORT-DISPLAY indicates the message "OFF".

7. Setting of temperatures





7.1. Using the pre-settings in the menu

Press the  key to call up the menu for temperature selection.

3 different working temperatures can be adjusted. Their values are freely selectable within the operating temperature range.

- ① The temperatures can be set in start or stop mode.
- ① Press  key if a value is to be retained

Setting of working temperature in the menu

1. Press the key . The value flashes .
2. Select SETPOINT 1 or 2 or 3 using the key  or .
3. Confirm by pressing the  key.

- ① The circulator uses the new working temperature value for temperature control.









Werkseinstellungen:

SETPNT 1 25 °C



SETPNT 2 37 °C

SETPNT 3 70 °C

Example: Adjustment/modification of the pre-setting of "SETPOINT 3"

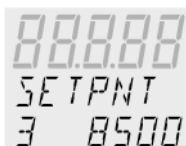
1. Press the  key.
2. Select SETPOINT 3 by pressing the  key.
Example: SETPNT 3 / 70.00 °C
3. Keep the  key pressed until the integer digits flash .
4. Adjust value by pressing the  key and the  key to 85.00 °C and confirm by pressing the  key.
The decimal digits flash  and can be adjusted if desired.
Confirm once more by pressing the  key.
Example on the left: SETPNT 3 / 85.00.





- ① If the active setpoint (SETPNT) is changed, the new value is immediately used for the control of the working temperature. The heater control indicator flashes.
- ① If the other two setpoints (not activated for control) are changed the  MENU has to be left by pressing the  key after the decimal digits have been confirmed



Notice: Refer to SETPOINT MAX / MIN in chapter >MENU LIMITS<

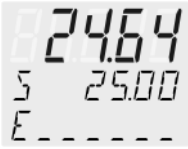

7.2. Direct setting of temperatures





The circulator uses the setpoint of SETPNT 1 or 2 or 3 for temperature control

The indicated setpoint temperature can be changed directly any time.
Example: change 25.00 °C to 50.00 °C



1. By pressing the key  the circulator switches to the active SETPOINT< example on the left: >SETPNT / 1 25.00°C<. The integer digits flash  (example: <25>).



2. By pressing the keys  and  the value is changed to 50.00 °C and is confirmed by pressing the **OK** key. The decimal digits flash and can be adjusted if desired. Confirm once more by pressing the **OK** key.



- ① The circulator uses the new working temperature value for temperature control.
- ① The temperatures can be set in start or stop mode.

8. Safety installations, warning functions



Check the safety installations at least twice a year! Refer to (page 14)

SECVAl
(Security Values)

- SAFETMP
- AL-TYPE
- OVERTMP
- SUBTEMP

Settings for the excess temperature protection > **SAFETMP**< and for the warning functions for high > **OVERTMP**< and low > **SUBTEMP**< temperature are made in a menu which is called up by pressing the key .

Menu item > **AL-TYPE**< allows choosing between a warning and an alarm cut-off for the menu items > **OVERTMP**< and > **SUBTEMP**<.

8.1. Excess temperature protection



Warning:

The excess temperature protection **must** be set at least 25 °C below the fire point of the bath fluid used!

In case of wrong setting there is a fire hazard!

We disclaim all liability for damage caused by wrong settings!



This excess temperature protection is independent of the control circuit. When activated heater and circulating pump are completely shut down. The alarm is indicated by optical and audible signals (continuous tone) and the error message "ALARM-CODE 14" appears on the VFD COMFORT-DISPLAY together with the ticker:
> *EXCESS TEMPERATURE PROTECTOR ALARM-CHECK ADJUSTMENT* <



Setting range: 20 °C ... 320 °C

ⓘ Rough setting can be effected by using the temperature scale.

Exact setting:

1. Press the key  to display menu >SAFETMP<.
2. Press the **OK** key and the set shutdown value is indicated.
3. Set the new shutdown value within 30 seconds using a screwdriver. The value is indicated on the VFD COMFORT-DISPLAY
Example: SAFETMP / 100 °C



Recommendation:

Set the excess temperature protection at 5 °C to 10 °C above the working temperature setpoint.

8.1.1. Early warning system, low level protection

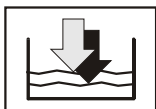

This low level protection is independent of the control circuit and is divided into two sections:

1. Switch in stage 1 recognizes a defined fluid level 😊.
An audible warning sounds (interval tone) and together with the ticker: *> LOW LEVEL WARNING-FILL MEDIUM <* a message appears on the VFD COMFORT-DISPLAY:

```

88.888
WARNING
CODE 40
    
```

Refill the bath fluid!

2. Switch in stage 2 recognizes a low fluid level ☹️.
If stage 2 of the low level protection according to IEC 61010-2-010 is triggered, a complete, all-pole shutdown of heater and circulating pump is effected
A continuous alarm sounds and together with the ticker: *> LOW LEVEL ALARM-FILL MEDIUM <* a message appears on the VFD COMFORT-DISPLAY:

```

- OFF -
ALARM
CODE 1
    
```

Turn off the unit with the mains switch, refill bath fluid and turn the unit on again!

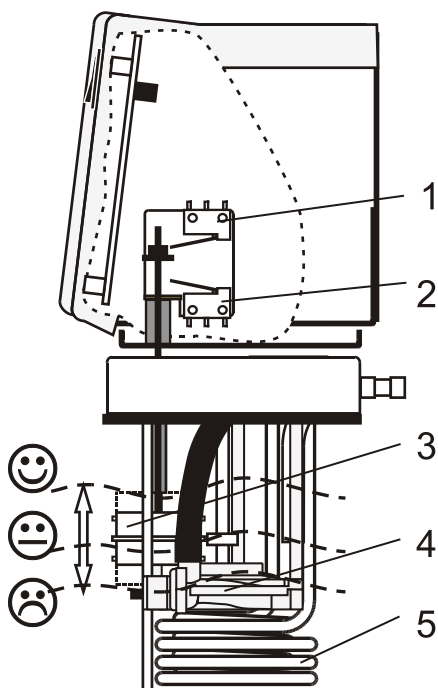

3. Float
4. Circulating pump
5. Heater



Warning:

When adding bath fluid, always use the type of fluid which is identical with the fluid in the bath.

Bath oils must not contain any water and should be pre-heated approximately to the current bath temperature! Explosion hazard at high temperatures!

8.2. Switch-over from warning to shutdown function





```
SECVAL
AL-TYPE
```

If a shutdown of functional elements (e.g. heater, circulating pump) is required when the limit values are exceeded or undercut the circulator can be changed over from warning function >WARNING< to shutdown function >ALARM<.

Factory setting:
>WARNING<

```
AL-TYPE
WARNING
```

```
AL-TYPE
ALARM
```

1. Press the key .
2. Select the menu >SECVAL -AL-TYPE< by pressing the  key.
3. Press the **OK** key and the set parameter will flash .
(Example: WARNING)
4. Change the parameter by pressing the  key and confirm by pressing the **OK** key.
or
press the  key if the parameter is to retained.

i Setting >WARNING<

A mere warning function with optical and audible warning signal (interval tone) A message appears on the VFD COMFORT-DISPLAY:

```

00000
WARNING
CODE 03  or  00000
OVERTMP     WARNING
              CODE 04
              SUBTEMP
```

• Setting >ALARM<

Temperature limit with shutdown of heater and circulating pump.
An audible alarm sounds (continuous tone) and a message appears on the VFD COMFORT-DISPLAY:

```

-0FF-
ALARM
CODE 03  or  -0FF-
OVERTMP     ALARM
              CODE 04
              SUBTEMP
```

8.3. Over and Sub temperature warning function

Over temperature



```
OVERTMP
200.00
```

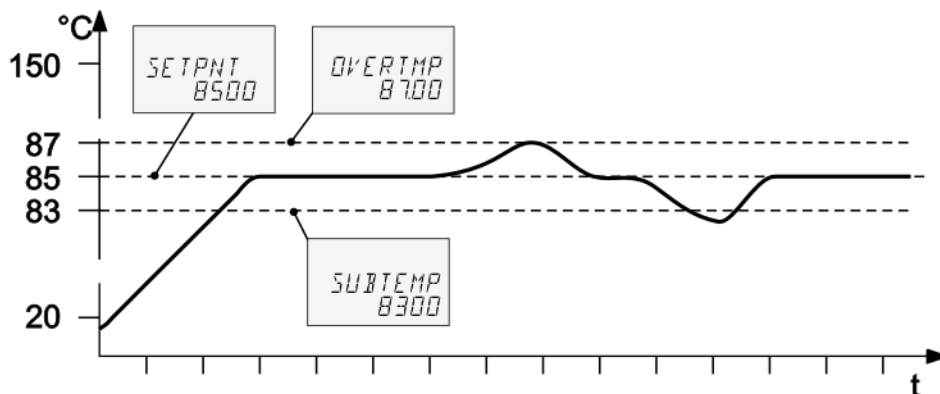

Sub temperature

```
SUBTEMP
-99.00
```

If the observance of a working temperature value >SETP< has to be supervised for a sensitive temperature application, then set over and sub temperature warning values. In the example below the SETPOINT 85 °C is surrounded by the values OVERTMP 87 °C and SUBTEMP 83 °C. The electronics immediately register if the actual temperature breaches one of the set limit values. The resulting reaction is defined in a further menu item. (See chapter 8.2.)



1. Press the key .
2. By pressing the  or  key select the menu >OVERTMP< or >SUBTEMP<.

1. Press the **OK** key. The integer digits flash
2. Change the values to 87. °C and/or 83. °C by pressing the  and  key and confirm with the **OK** key.
The decimal digits flash and can be adjusted if desired.
Confirm once more by pressing the **OK** key.
See above examples.

- The warning functions are only activated if the actual bath temperature remains within the set limit values for 3 seconds after switch-on.







Recommendation:

Set the over temperature warning value >OVERTMP< 5 °C to 10 °C above the working temperature setpoint.

Set the sub temperature warning value >SUBTEMP< 5 °C to 10 °C below the working temperature setpoint.









9. **MENU** Menu functions

1. Open the menu by pressing the **MENU** key.
2. Use the   keys to scroll in menu level 1.
3. Press the  key to change to menu level 2.
Press the  key if settings are to be retained.

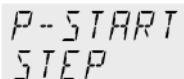
MENU ↓

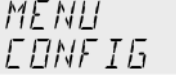
The term „Menu functions“ refers to settings such as

Menu level 1

  → 	Start program	Page 32
	Administration and creation of programs	Page 35
	Electronically adjustable pump capacity	Page 37
	Configuration of the unit REMOTE – on / off (remote control via RS232) AUTOST – AUTOSTART on / off OFF-MODE – pump on / off TIME / DATE – setting time and date RESET – factory settings	Page 38
	Control characteristics and parameters C-TYPE – Internal or external control DYNAMICS - internal Control parameter - XP-, TN-, TV- INTERNAL Control parameter - XP-, TN-, TV- XPU-, EXTERNAL	Page 42
	Adjustable interface parameters BAUD RATE, PARITY, HANDSHAKE	Page 48
	ATC - Absolute Temperature Calibration, Sensor calibration INTERNAL SENSOR, Sensor calibration EXTERNAL SENSOR 3-point calibration	Page 49
	Limitations of temperature and capacity SETPOINT MAX / MIN - Maximum and minimum setpoint HEAT MAX – Set maximum heating COOLING MAX – Set maximum cooling INTERN MAX / MIN – Limitation of the temperature range BAND HIGH / LOW – Band limit	Page 55

	Analog inputs/outputs Recorder output – CHANNEL 1, 2, 3 EPROG – External programmer input EX-STBY - STAND-BY input ALARM - output	Page 58
---	---	---------

9.1. MENU PROGRAM – START

Start-Menu

Menu level 1













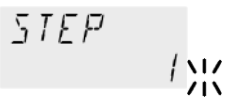

This menu will start a previously set program.



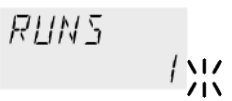



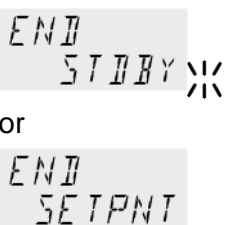



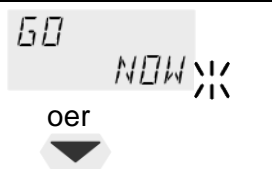











i Requirements:

1. Create a program. (refer to next chapter)
2. Return to the Start-MENU and confirm the desired setting of each MENU item with the key **OK**
3. Set a start time (>TIME< >DATE< >YEAR<) if the program is to be started by the internal timer.

- > STEP< Program start at section 1 ... 10
- > RUNS < Number of repetitions 1 ... 99
- > END< Status at end of program (STDBY/SETPNT)
 Standby or last setpoint
- > GO < Time of start (NOW/TIMER)

i Press the  key if a parameter is to be retained.
Correction function for parameters or values (prior to OK)

Level 2	Parameter level	
		<ul style="list-style-type: none"> • Set program step with   and OK example: STEP 1
		<ul style="list-style-type: none"> • Set number of runs with   and OK example: 1 run
		<ul style="list-style-type: none"> • Set desired parameters with   and OK. i (STDBY / SETPNT) Parameter STanDBY: the circulator switches to – OFF-. Parameter SETPoiNT: the circulator constantly keeps the temperature at the value of the last step.

Level 2	Parameter level	
		<ul style="list-style-type: none"> Confirm >NOW< with the OK key and the program will start immediately
		<ul style="list-style-type: none"> i or start at the set time under parameter (TIMER). Set time in the example below: 09. August 2009, 11:15 hrs i set the time for the start of the program in the submenu >TIMER<.
Submenu TIMER	Parameter level	
		<p>>TIME< hours/minutes (hh:mm), set both values one after the other and confirm</p> <ul style="list-style-type: none"> hours flash, set by pressing   + OK minutes flash, set by pressing   + OK
		<p>>DATE< day/months (TT/MM), set both values one after the other and confirm.</p> <ul style="list-style-type: none"> day flashes, set by pressing   + OK month flashes, set by pressing   + OK
		<p>>YEAR< year</p> <ul style="list-style-type: none"> Set the year with   and OK .
		<ul style="list-style-type: none"> i The program starts at the set time.
		<ul style="list-style-type: none"> i Display of time until start: In line 3 the notice >TIMER< and the set values for „TIME“ and „DATE/YEAR“ are alternately indicated i Check the correct setting of the internal real time clock if required (see MENU CONFIG)

The started program

After the start the program will indicate the currently calculated setpoint in line 2

S XX.XX. The value increases within the time period >TSLICE< until the target temperature >SETPNT< of the section is reached.

If the time period in a section is set to „0“, the next section will not begin until the target temperature has been reached.

A

B

C1

C2

D1

D2

Use the edit keys to scroll to line 3. The display changes approximately every 4 seconds between the current section (STEP XX) and the

A remaining time of the section

B remaining time of the program

C current bath temperature

I xxx.xx - internal actual value or

E xxx.xx – external actual value

D RUN – the program has started or

PAUSE – the progress of the program has been interrupted by pressing the key. While the time is stopped the temperature will constantly remain at the last calculated setpoint

Continue with the key.

Termination / Interruption of a program

ⓘ The program can be terminated any time by pressing the key .

ⓘ In case of power failure the program is interrupted.
The circulator switches to –OFF- .

ⓘ If the AUTOSTART-function is activated the programmer starts again at the point in time approx. 5 minutes prior to the interruption. However, an uncontrolled change of the bath temperature has occurred.

9.2. MENU PROGRAM – creation, administration

Menu level 1

MENU
PROGRAM

1 program







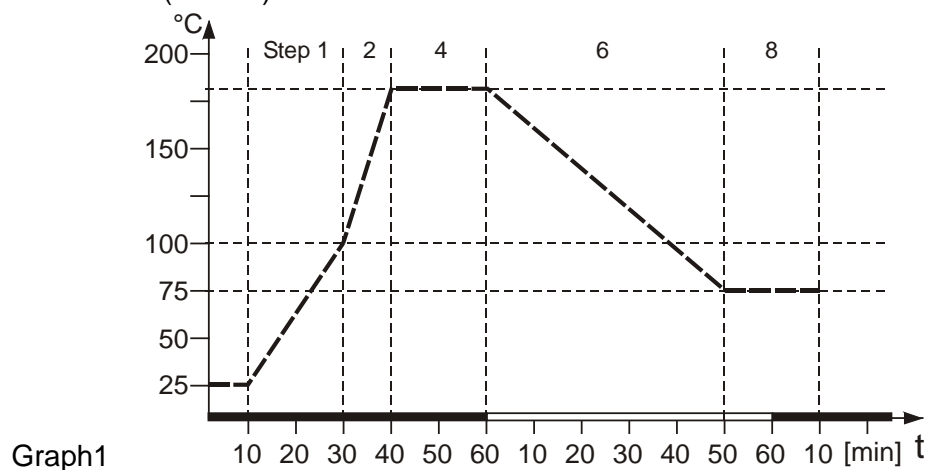



















10 sections

The integrated programmer permits fast and easy programming of setpoint temperature sequences. This temperature sequence is called program. A program is composed of individual sections (STEP). The sections are defined by duration (TSLICE) and target temperature. The target temperature is the setpoint (SETPNT), which is achieved at the end of a section. The programmer calculates the temperature ramp from the difference in time and temperature.

STEP	(Nr.)	1	2	4	6	8
SETPNT	(°C)	100	180	180	75	75
TIME	(hh.mm)	00:20	00:10	00:20	00:50	00:20

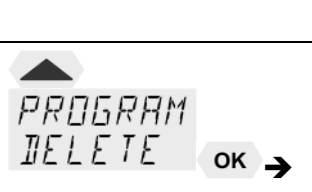

- ① Sections without set value and time are skipped. They can be defined retroactively and the integrated into the program.

<p>Menu level 1</p> 	<p>>EDIT< Create, administer program > STEP< Program step (1 ... 10) >SETPNT < Temperature setpoint of step ... >TSLICE< Duration of step ... > DELETE< delete program step (01 ... 10, ALL)</p> <p>ⓘ Press  key, if a parameter is to be retained. Correction function for parameters or values (prior to OK)</p>	
Level 2	Level 3	Parameter level
	 	<p>STEP 1  (STEP 1 ... 10)</p> <ul style="list-style-type: none"> Set program step with   and  <p>← (Example: EDIT STEP 01)</p> <p>ⓘ For STEP 01 the values for SETPOINT 01 and TSLICE 01 are set one after the other</p>
		<p>SETPNT 10000  (values within working temp. range)</p> <ul style="list-style-type: none"> Integer digits flash, set by pressing   +  Decimal digits flash, set by pressing   + 
	 (time slice)	<p>TSLICE 00.10 </p> <ul style="list-style-type: none"> Set duration by pressing   and 
		<p>ⓘ Delete program Program steps can be deleted individually or entirely. (STEP 01, 02,... 10, ALL).</p> <ul style="list-style-type: none"> Set parameters by pressing   and 

9.3. MENU PUMP - Setting of pump pressure



The pressure of the circulating pump is adjustable in four stages. After setting, the VFD COMFORT-DISPLAY indicates the corresponding value.

Adjustable pump capacity stage 1 ... 4

Examples:

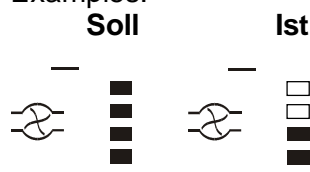

Illuminated display: for pump pressure

i Adjusted: Display for the adjusted pump pressure stage in the –OFF– mode.

i Effective: Display for the effective pump pressure stage (rotation speed) after start.

For protecting the pump motor, the rotation speed (i.e. the pump pressure stage) changes with the load applied.

Example: The viscosity of the bath fluid (i.e. the load applied to the pump motor) changes with the working temperature in the bath.

Flow rate: 22 ... 26 l/min

Pump capacity stage	1	2	3	4
Pump pressure [bar]	0.4	0.5	0.6	0.7
Suction pump [bar]	0.2	0.26	0.33	0.4
Total capacity in a loop circuit [bar]	0.6	0.76	0.93	1.1















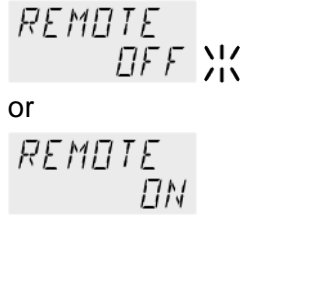



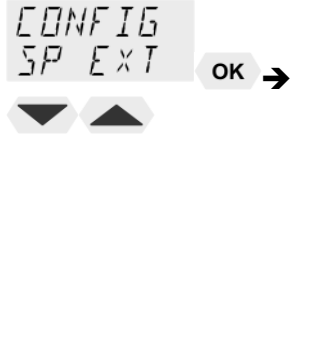
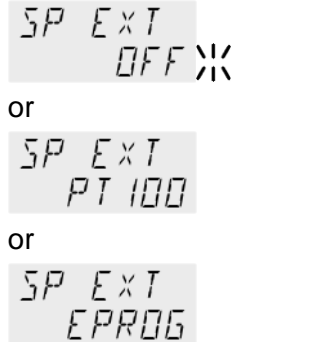











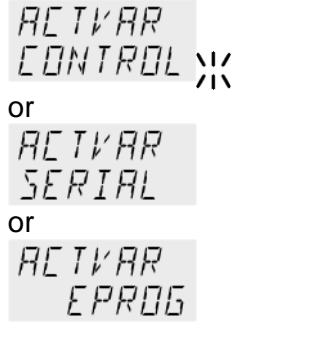













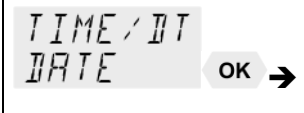





Factory setting:
stage 1



1. Press the **MENU** key.
2. Select the menu >PUMP< pressing the key and confirm by pressing the **OK** key
The set parameter flashes (example: >LEVEL 2<)
3. Change the parameter by pressing and confirm by pressing the **OK** key.
or
Press the key if the parameter is to be retained.

9.4. MENU CONFIG - Configuration of unit

<p>Menu level 1</p> 	 <p>① A RESET can be effected only in the >OFF< mode. Switch off circulator by pressing the OK key and call up the menu CONFIGURATION.</p>	
<p>Level 2</p>	<p>Parameter level</p>	<p>① Press the key  if a parameter is to be retained. Correction function for parameters and values (prior to OK).</p>
		<ul style="list-style-type: none"> • Switch on and off remote control by pressing   and OK ① Control display in the topline R for Remote ① For remote control refer to 71 ①   Connect RS232 with PC.
		<ul style="list-style-type: none"> • Switch over setpoint setting by pressing   and OK ① OFF –Setpoint setting with the navigation keys or Setpoint setting via the analog socket „ext. Pt100 or analog socket >REG+EPROG<
		<ul style="list-style-type: none"> • Switch on and off autostart by pressing   and OK AUTOSTART on = on AUTOSTART off = off See WARNING page 40
		<ul style="list-style-type: none"> • Switch on and off OFFMODE by pressing   and OK PUMP ON continuous operation of circulating pump PUMP OFF circulating pump is linked to Start/Stop
		<ul style="list-style-type: none"> • Switch over the input variable by pressing   and OK ① Programming of variables for the parameters > SERIAL < or > EPROG < is only accepted, if the unit is in Start mode

Level 2	Level 3	Parameter level
		 <ul style="list-style-type: none"> • Hours flash, set by pressing   +  • Minutes flash, set by pressing   + 
		 <ul style="list-style-type: none"> • Day flashes, set by pressing   +  • Month flashes, set by pressing   + 
		 <ul style="list-style-type: none"> • Year flashes, set by pressing   + 
		<ul style="list-style-type: none"> • Return to factory settings by pressing  <p>RESET returns all set values to the factory setting except for date and time.</p> <ul style="list-style-type: none"> ① A RESET can be effected only in the –OFF- mode. ① During the message –RUN- all parameters are reset to factory settings.

9.4.1. Remote control via the serial interface

Factory setting: OFF

The control electronics offer two ways of adjusting a setpoint.

1. Adjustment of setpoint using the keypad or the integrated programmer.
2. Adjustment of setpoint via the serial interface RS232 using a PC or a superordinated process control system.

① The topline of the VFD-DISPLAY shows a bright „R“ for remote control; - remote control discontinued.

○  ○
RS232

IMPORTANT: additional measures for remote control

- ① Connect the circulator to the PC using an interface cable.
- ① Check the interface parameters of both interfaces (circulator and PC) and make sure they match.
(refer to 12.1. Setup for remote controll page 71)

9.4.2. Keypad control or setpoint setting via the analog input

Factory setting:: OFF

```
CONFIG
SP EXT
```

In addition to the serial interface via remote control the new circulator offers the possibility to adjust the setpoint via analog interface >ext. Pt100< or >REG+E-PROG<.

The selected mode is indicated on the VFD COMFORT-DISPLAY

```
S  X.X.XX OFF
I  X.X.XXX
```

OFF - Setpoint setting with the navigation keys or the integrated programmer.

```
ST X.X.XX PT100
I  X.X.XXX
```

PT100 - Setpoint setting via the analog socket „ext. Pt100“ using an external temperature sensor or an appropriate voltage/current source.

```
SP X.X.XX EPROG
I  X.X.XXX
```

EPROG - Can only be adjusted when an electronic module with analog connections is used (option). Setpoint setting via the analog interface REG+E-PROG connection with an external voltage or current source or a programmer.

```
CONFIG SP EXT
SP EXT > EPROG
```

```
CONFIG ACTVAR
ACTVAR > EPROG
```

Important:

Connect the external voltage or current source or a programmer to the circulator via the socket REG+E-PROG (see page 62). In the menu >MENU IN/OUT< set the parameter >EPROG-INPUT< and the input variables >EPROG-SIGNAL< (see page 62).

The E-Prog input can only be used either under menu item >SP EXT < or under menu item >ACTVAR< (see page 41).

9.4.3. AUTOSTART



Warning

For supervised or unsupervised operation with the “AUTOSTART“ function avoid any hazardous situation to persons or property

Take care to fully observe the safety and warning functions of the circulator.

Factory settings: OFF

Notice:

The circulator has been configured and delivered by JULABO in accordance with the NAMUR recommendations. This means for the start mode that the unit must enter a safe operating status after a power failure. This safe operating status is indicated by the message „**OFF**“ or „**R OFF**“ on the VFD COMFORT-DISPLAY.

A complete, all-pole shutdown of the main functional elements such as heater and pump motor is effected.

The values set on the circulator remain saved and the unit is restarted by pressing the start/stop key in manual control.

In remote control mode the values need to be resent by the PC via the interface.

If such a safety standard is not required, the NAMUR recommendations can be bypassed with the AUTOSTART function thus allowing a direct start of the circulator by pressing the mains switch or using a timer.

9.4.4. OFF-MODE

Factory setting:
PMP OFF

Usually the circulating pump is controlled with the key **OK** or the start/stop command. If the circulating pump is to work in the –OFF-mode, the adjustment can be set in a sub-menu.

 The pump motor will be shutdown in case of alarm anyhow.

9.4.5. ACTVAR - actuating variable

Factory setting:
CONTROL

The variable (*ACTuating VARIable*) corresponds to the extent to which the heater or cooling unit of the circulator is controlled. Heat or cold is applied to the bath according to this variable. If this happens with the control electronics of the circulator, called > CONTROL < in this particular case, the bath temperature is exactly heated and maintained constant at the adjusted setpoint.

 Programming of variables for the parameters > SERIAL < or > EPROG < is only accepted, if the unit is in Start mode.

```
ACTVAR
CONTROL
```

```
ACTVAR
SERIAL
```

```
ACTVAR
EPROG
```





Possible parameters:

CONTROL – The internal control electronics of the circulator controls the heater und the connected cooling unit. Self-tuning is possible.

SERIAL – The heater or the connected cooling unit receives the control signal via the serial interface. Self-tuning is not possible.

EPROG - The heater or the connected cooling unit receives the control signal via the E-Prog input. Self-tuning is not possible.

Important:

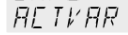
Under   set the input variable >EPROG U/I<  to   (refer to page 62).

```
CONFIG  SP EXT
SP EXT  EPROG
```

```
CONFIG  ACTVAR
ACTVAR  EPROG
```

Note:

The E-Prog input can only be used either under menu item >SP EXT< (refer to page 40) or under menu item > **ACTVAR** <.



Warning:

The working temperature range of the circulator is determined during configuration. If set to >CONTROL<, this range cannot be exceeded.

If set to > **SERIAL** < and > **EPROG** <, heat or cold is applied to the bath without control. The permissible maximum temperature can be exceeded. The user has to take adequate precautions for temperature control.

Materials, such as gaskets or insulations for example, may be damaged or destroyed, if the permissible maximum temperature is exceeded.

The safety and warning functions >  < of the instrument must always be used to their fullest capacity.

9.4.6. Setting of clock and date



The internal real time clock allows starting a program any time. The clock is set to the local mean time (MEZ) at the factory.

- ① If the unit is operated in a different time zone, the clock can be adjusted in this menu.
- ① Change summer/winter time in this menu

9.4.7. RESET – Factory settings



A Reset will return all values to factory setting except for date and time.

- ① A RESET can be effected in the >OFF< mode only.
Switch off the circulator by pressing the key **OK** and call up the menu CONFIGURATION.

9.5. MENU CONTROL – Control characteristics and parameters

Menu level 1



The circulator is qualified for internal and external temperature control
The switchover is carried out in the menu >C-TYPE< .(INT or EXT).

- ① For external temperature control and measurement connect a Pt100 external sensor to the socket at the rear of the circulator.
- ① Press the key if a parameter is to be retained. Correction function for parameters or values (prior to OK)

Level 2



Parameter level

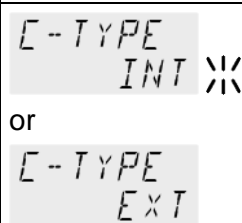

- ① The parameter flashes, switch by pressing and **OK**
- ① The control type can be adjusted in the **-OFF-** mode only.
- ① Depending on the adjustment only the active parameters are displayed.

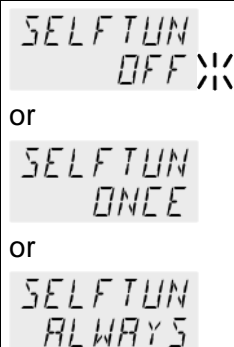

- ① The parameter flashes, switch by pressing and **OK**
- ① OFF - no selftuning.
- ① ONCE - single selftuning (factory setting)
- ① ALWAYS - continual selftuning.

Level 2	Parameter level	
C-TYPE INTERNAL		
CONTROL DYNAMIC OK → ▼ ▲	DYNAMIC APER ✖ or DYNAMIC NORM	<ul style="list-style-type: none"> The parameter flashes, switch by pressing ▲ ▼ and OK ⓘ This parameter affects the temperature sequence in case of internal control.
CONTROL xP INT OK → ▼ ▲	xP INT 15 ✖ 0.1 ... 99.9	<ul style="list-style-type: none"> The parameter flashes, set by pressing ▲ ▼ + OK
CONTROL TN INT OK → ▼ ▲	TN INT 100 ✖ 3 ... 9999	<ul style="list-style-type: none"> The parameter flashes, set by pressing ▲ ▼ + OK
CONTROL TV INT OK → ▼ ▲	TV INT 5 ✖ 0 ... 999	<ul style="list-style-type: none"> The parameter flashes, set by pressing ▲ ▼ + OK
C-TYPE EXTERNAL		
CONTROL xP EXT OK → ▼ ▲	xP EXT 0.7 ✖ 0.1 ... 99.9	<ul style="list-style-type: none"> The parameter flashes, set by pressing ▲ ▼ + OK
CONTROL TN EXT OK → ▼ ▲	TN EXT 720 ✖ 3 ... 9999	<ul style="list-style-type: none"> The parameter flashes, set by pressing ▲ ▼ + OK
CONTROL TV EXT OK → ▼ ▲	TV EXT 55 ✖ 0 ... 999	<ul style="list-style-type: none"> The parameter flashes, set by pressing ▲ ▼ + OK
CONTROL xPU OK → ▼ ▲	xPU 30 ✖ 0.1 ... 99.9	<ul style="list-style-type: none"> The parameter flashes, set by pressing ▲ ▼ + OK

9.5.1. CONTROL – Control INTERNAL / EXTERNAL

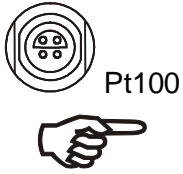

❗ Switchover can only be effected if a Pt100 external sensor is connected.

Factory setting: INT

IMPORTANT: Additional measures for external temperature control

❗ Suggested settings for external temperature control:
BAND HIGH / LOW and INTERN MAX / MIN
see chapter >MENU LIMITS<

❗ Sensor calibration of the Pt100 external sensor is carried out in the menu >ADJUST<, submenu >ATC SENOR - EXT<; set ATC STATUS< to >OFF<
(See page 49).



Attention:

Place the external sensor into the temperature-controlled medium and securely fix the sensor.

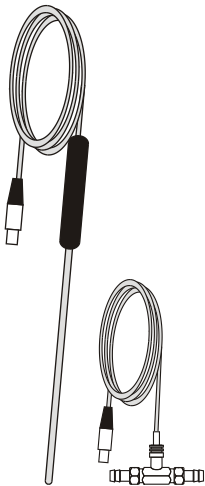

Pt100

M+R

Accessory: Pt100 external sensor

Order No.	Description	Material	Cable
8981003	200x6 mm Ø,	stainless steel	1.5 m
8981005	200x6 mm Ø,	glass	1.5 m
8981006	20x2 mm Ø,	stainless steel	1.5 m
8981010	300x6 mm Ø,	stainless steel	1.5 m
8981015	300x6 mm Ø,	stainless steel / PTFE coated	3 m
8981013	600x6 mm Ø,	stainless steel / PTFE coated	3 m
8981016	900x6 mm Ø,	stainless steel / PTFE coated	3 m
8981014	1200x6 mm Ø,	stainless steel / PTFE coated	3 m
8981103	Extension cable for Pt100 sensor		3.5 m
8981020	M+R in-line Pt100 sensor		

The M+R in-line Pt100 sensor is a flow sensor and can be installed loop circuit

9.5.2. SELFTUNING

SELFTUN
OFF

Selftuning:

When performing a selftuning for the controlled system (temperature application system), the control parameters X_p , T_n and T_v are automatically determined and stored.

Possible parameters:

OFF - no selftuning

The control parameters ascertained during the last identification are used for control purposes.

ONCE - single selftuning (factory setting)

The instrument performs a single selftuning of the controlled system after each start with the **OK** key or after receiving a start command via the interface.

ALWAYS - continual selftuning

The instrument performs a selftuning of the controlled system whenever a new setpoint is to be reached.

Use this setting only when the temperature application system changes permanently.

9.5.3. Dynamic internal

CONTROL
DYNAMIC

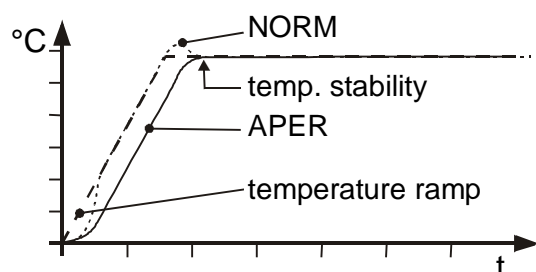
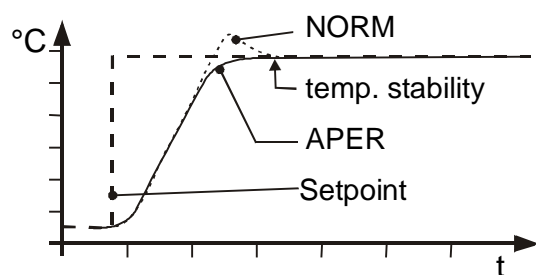

This parameter affects the temperature sequence only in case of internal control.

Factory setting: APER (aperiodic)

Possible parameters:

NORM Allows for reaching the setpoint faster – with setpoint change or ramp function – but overshooting of up to 5 % is possible.

APER Ramp function: the increase of temperature occurs temporally offset and achieves the target temperature without overshooting. Setpoint change: The temperature increases at the same rate, the target temperature is achieved without overshooting.

ⓘ With both settings constant temperature is achieved after approximately the same time.

9.5.4. Control parameters– XP-, TN-, TV- INTERNAL

In most cases the control parameters preset in the factory are adequate for achieving an optimum temperature sequence. The control parameters allow adjustment to special control processes..

```
XP INT
  15
```

Setting range: 0.1 ... 99.9

Proportional range >Xp<

The proportional range is the range below the setpoint in which the control circuit reduces the heating capacity from 100% to 0 %

```
TN INT
 100
```

Setting range: 3 ...9999

Reset time >Tn< (Integral component)

Compensation of the remaining control deviation due to proportional regulation. An insufficient reset time may cause instabilities. Excessive reset times will result in unnecessary prolongation of compensation of the control difference.

```
TV INT
  5
```

Setting range: 0 ... 999

Lead time >Tv< (Differential component)

The differential component reduces the transient time. An insufficient lead time will prolong the time required for compensation of disturbance effects and cause high overshooting during run-up. An excessive lead time could cause instabilities (oscillations)

Optimization instructions for the PID control parameters

Optimum setting

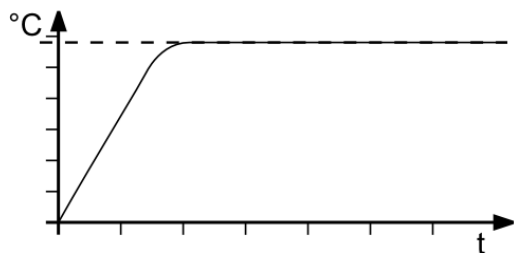

Control parameters XP-, TN-, TV- INTERNAL as well as -EXTERNAL

The heat-up curve reveals possible faulty settings of the control parameter.

Inappropriate settings may produce the following heat-up curves:

Xp too low

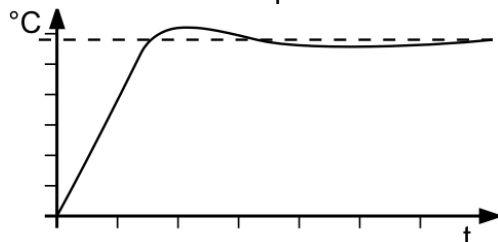

Tv/Tn too low

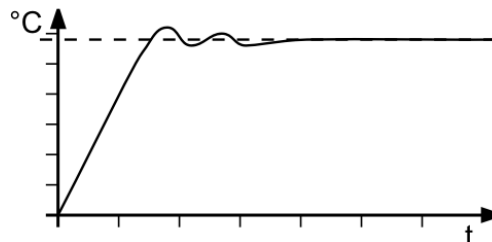

Xp too high or Tv too high

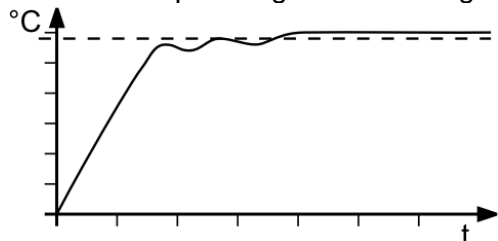

Tv/Tn too high or Xp too high

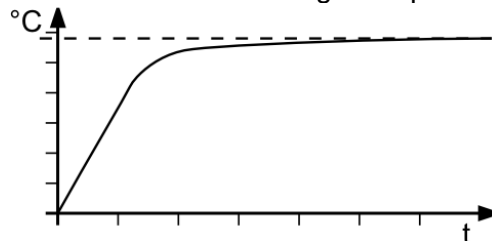

9.5.5. COSPEED - external

```
COSPEED
  00
```

This parameter affects the temperature pattern only in case of **external** control.

Possible parameters: 0.0 ... 5.0

During selftuning, the control parameters X_p , T_n and T_v of a controlled system are automatically determined and stored. Depending on the controlled system, time for tuning can be unequally longer. This controller layout allows protection of sensitive objects requiring temperature application.

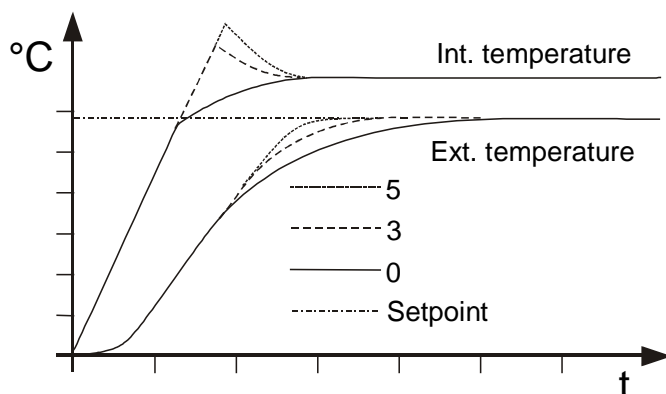

As soon as a co-speed factor is set, it is considered for calculating the control parameters. As shown in the diagram, tuning times become shorter the higher the co-speed factor is, but overshooting can happen in the internal system.

9.5.6. Control parameters – XPU-, XP-, TN-, TV- EXTERNAL

```
xP EXT
  0.7
```

Setting range: 0.1 ...99.9

```
TN EXT
  720
```

Setting range: 3 ...9999

```
TV EXT
  55
```

Setting range: 0 ... 999

```
xPU
  30
```

Setting range: 0.1 ... 99.9

In most cases the control parameters preset in the factors are adequate for achieving an optimum temperature sequence.

The control parameters allow adjustment to special control processes.

Proportional range >Xpu<

The proportional range X_{pu} of the cascaded controller is only needed for external control.

9.6. MENU SERIAL - BAUDRATE, HANDSHAKE, PARITY

Menu level 1













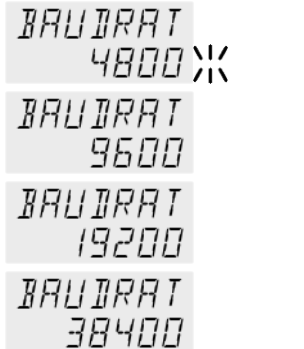





For communication between circulator and a PC or a superordinated process control system the interface parameters of both units must be identical.

① For remote control refer to page 71

Factory settings:

- 4800 Baud
- even
- hardware handshake

Level 2	Parameter level	① Press the  key if a parameter is to be retained.
		<ul style="list-style-type: none"> • The parameter flashes, switch by pressing   and 
		<ul style="list-style-type: none"> • The parameter flashes, switch by pressing   and  <p>even: Data bits = 7; Stop bits = 1 odd: Data bits = 7; Stop bits = 1 no: Data bits = 8; Stop bits = 1</p>
		<ul style="list-style-type: none"> • The parameter flashes, switch by pressing   and  <p>Xon/Xoff-protocol (Software handshake) Protocol RTS/CTS (Hardware handshake)</p>

9.7. MENU ATC - Absolut Temperature Calibration

MENU
ATC

ATC serves to compensate a temperature difference that might occur between circulator and a defined measuring point in the bath tank because of physical properties.

Example:

1-point calibration

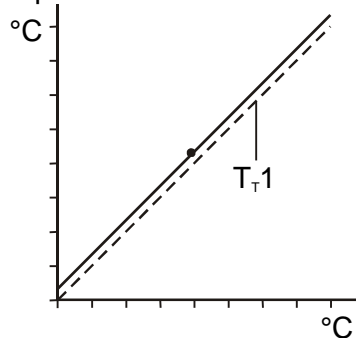

3-point calibration

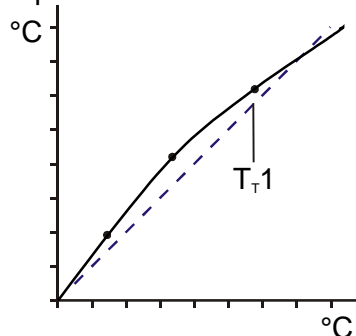

T_{T1} = Original curve

Principle:

For ATC calibration, in steady state the bath temperature at the location of the temperature sensor (CT) is determined at the respective adjusted working temperature. This value is then set on the circulator in the menu >ATCalibration< under menu item >CTEMP X<. This can be a 1-point, 2-point or 3-point calibration.

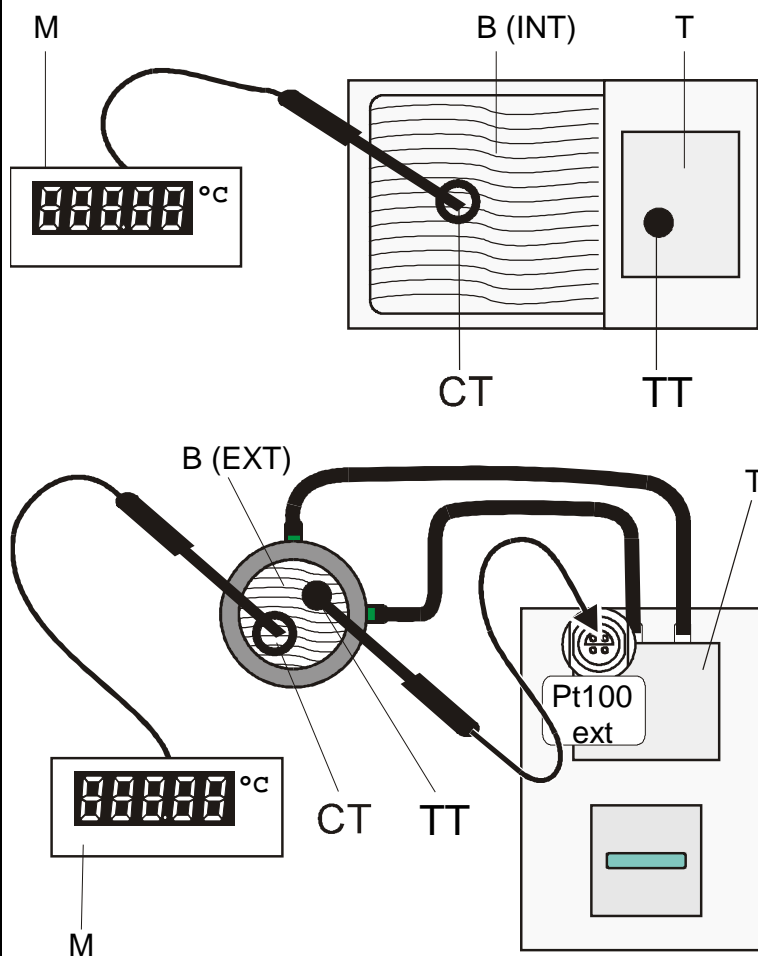

M = Temperature measuring instrument with temperature sensor













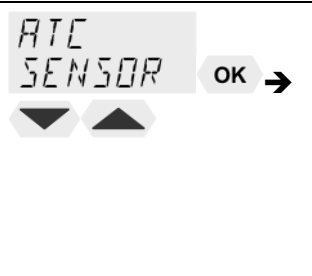

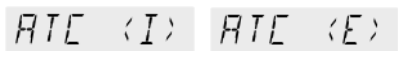
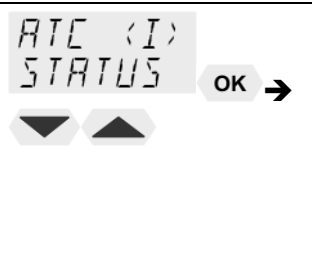

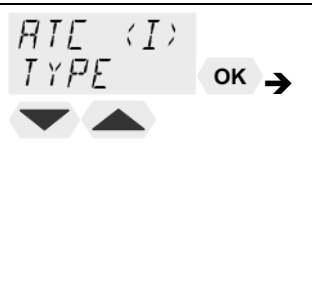

B = Bath tank (INTernal or EXTernal)

T = circulator

CT = Temperature on measuring point

TT = Temperature on circulator

Menu functions

<p>Menu level 1</p> 		
<p>Level 2</p>	<p>Parameter level</p>	<p>ⓘ Press the  key if parameter is to be retained. Correction function for parameters or values (prior to OK).</p>
	<p>SENSOR INTERN** or SENSOR EXTERN</p>	<ul style="list-style-type: none"> The parameter flashes, switch by pressing  and  ⓘ On level 2 a (I) is indicated for internal or an (E) for external. Example: 
	<p>STATUS YES** or STATUS NO</p>	<ul style="list-style-type: none"> The parameter flashes, switch by pressing  and  ⓘ >NO< Carry out an ATC calibration ⓘ >YES< return to standard operation after calibration.
	<p>TYPE I-POINT** TYPE 2-POINT TYPE 3-POINT</p>	<ul style="list-style-type: none"> The parameter flashes, switch by pressing  and  ⓘ A >1-point<, >2-point< or >3-point< calibration can be carried out. <p>The selected calibration is indicated on level 2 by 1 or 2 or 3.</p>
 	<p>TMPVALI 80.00 </p> <p>CALVALI 79.70**</p>	<p>The value >TMPVAL< is only indicated</p> <ul style="list-style-type: none"> ⓘ In addition the measured temperature value >CALVAL X< is saved during the next step. Integer digits flash, set by pressing  +  Decimal digits flash, set by pressing  + 
<p>ⓘ If only a 1-point calibration is carried out, the following menu items are not indicated anymore</p>		
<p>Level 2</p>	<p>Parameter level</p>	
	<p>TMPVAL2 120.00 </p>	<p>The value is only indicated</p>

Level 2	Parameter level	
<pre> ATC <I> CALVAL2 OK → ▲ ▼ </pre>	<pre> CALVAL2 11950 ✖ </pre>	<ul style="list-style-type: none"> Integer digits flash, set by pressing ▲ ▼ + OK Decimal digits flash, set by pressing ▲ ▼ + OK
<p>① If only a 2-point calibration is carried out, the following menu items are not indicated anymore.</p>		
<pre> ATC <I> TMPVAL3 OK → ▲ ▼ </pre>	<pre> TMPVAL3 16000 ↻ </pre>	The value is only indicated
<pre> ATC <I> CALVAL3 OK → ▲ ▼ </pre>	<pre> CALVAL3 15930 ✖ </pre>	<ul style="list-style-type: none"> Integer digits flash, set by pressing ▲ ▼ + OK Decimal digits flash, set by pressing ▲ ▼ + OK

9.7.1. ATC SENSOR - INTERNAL / EXTERNAL

```

ATC
SENSOR
          
```

```

SENSOR
INTERN
          
```

```

SENSOR
EXTERN
          
```

In the first submenu the ATC function is set for the >INTERN< internal or the >EXTERN< external temperature sensor.

Calibration can be carried out for the internal temperature sensor and for the external temperature sensor connected to the socket „ext. Pt100“.

The circulator is able to save both parameter sets. However only the one which has been set under menu item >ATC SENSOR < is displayed.

9.7.2. ATC STATUS - YES / NO

```

ATC <I>
STATUS
          
```

```

STATUS
YES
          
```

```

STATUS
NO
          
```

In the second submenu the ATC function for the temperature sensor selected above is activated >YES< or deactivated >NO<.

>YES< (factory setting) The controller of the circulator uses the original curve of the temperature sensor or the new curve measured during the ATC calibration.

Important: Set to >NO< during the calibration process

>NO< An ATC calibration is to be carried out.

Important: Set to >YES< after calibration.

① In the > ATC STATUS < >YES< the ATC calibration always affects the current working temperature; also the one set via interface.

9.7.3. CALIBRATION TYPE: 1 -/ 2 -/ 3 POINT

```
ATE (I)
TYPE
```

```
TYPE
1-POINT
```

```
TYPE
2-POINT
```

```
TYPE
3-POINT
```

A >1-point<, >2-point< or >3-point< calibration can be carried out.

First geometrically define the location for calibration (measuring point CT), then determine the temperature values of the calibration points.

The type of calibrations also determines the number of the following pairs of values indicated on the LCD DIALOG-DISPLAY.

```
TMPVAL1 CALVAL1
8000 79.70
```

```
TMPVAL2 CALVAL2
12000 119.50
```

```
TMPVAL3 CALVAL3
16000 159.30
```

Pairs of values:

TMPVAL X: Circulator temperature 1 or 2 or 3 (actual value TT)

The actual temperature of the bath is simultaneously saved with the "calibration value" >CALVAL< and can be indicated for control purposes (value does not flash).

CALVAL X: Calibration temperature 1 or 2 or 3 (actual value CT)

The „calibration value“ is determined with a temperature measuring device and saved under menu item >CALVAL<.

(value flashes $\overline{\text{X}}$)

9.7.4. Example: 3-point calibration for internal control

In the temperature range from 80 °C to 160 °C the calibration curve of the temperature sensor (TT) is to be adjusted to the actual temperatures at measuring point (CT).

1. Set circulator to internal control: MENU CONTROL page 42

Menu level 1

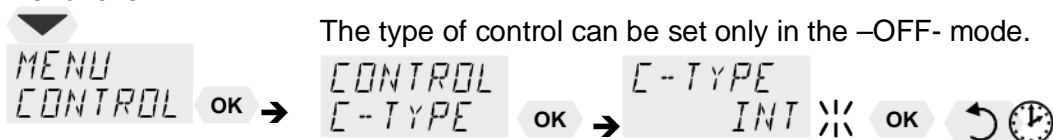

The type of control can be set only in the –OFF- mode.

2. Set working temperature setpoint – SETPNT:

Refer to „Direct temperature setting “ page 26



80.00 °C
120.00 °C
160.00 °C

- By pressing the key the circulator switches to the active >SETPOINT< see example on the left: >SETPNT / 1 25.00°C<. The integer digits flash (Example: <25>).
- Change the value to 80.00 °C by pressing the keys and and confirm by pressing the key . The decimal digits flash.
- Confirm once more by pressing the key .
- The bath is heated up.
Wait for approx. 5 minutes until the temperature is constant.

3. Reading of temperature measuring device



Read the value of measuring point CT on the device and enter under menu item >CALVAL X< by using the keypad.

- >CALVAL 1< (79.70 °C)
- >CALVAL 2< (119.50 °C)
- >CALVAL 3< (159.30 °C)

4. Calibration

Menu level 1



- ① Press the key if parameter is to be retained. Correction function for parameters or values (prior to OK).
- ① Setting is required only for the first calibration point.

Level 2



Parameter level



Set SENSOR INTERN:

- The parameter flashes, switch by pressing and .



An ATC calibration is to be carried out.
Set to >NO<

- The parameter flashes, switch by pressing and .

Menu functions

<pre> ATE <I> TYPE OK → ▼ ▲ </pre>	<pre> TYPE 3-POINT ✖ ◉ </pre>	<ul style="list-style-type: none"> The parameter flashes, switch by pressing ▲ ▼ and OK . <p>A >3-point< calibration is carried out.</p>
<pre> ATE <I> TMPVAL1 ▼ ▲ ATE <I> CALVAL1 ▼ ▲ </pre>	<pre> TMPVAL1 8000 ↻ </pre> <pre> CALVAL1 79.70 ✖ </pre>	<p>The value >TMPVAL< is only indicated In addition the measured value >CALVAL X< is saved during the following step</p> <ul style="list-style-type: none"> Integer digits flash, set by pressing ▲ ▼ (79) + OK Decimal digits flash, set by pressing ▲ ▼ (70) + OK <p>The first of 3 points is calibrated.</p>
<p>Return to 2. Set working temperature value SETPNT: 120.00 °C</p>		
<pre> ATE <I> TMPVAL2 ▼ ▲ </pre>	<pre> TMPVAL2 12000 ↻ </pre>	<p>The value is only indicated</p>
<pre> ATE <I> CALVAL2 ▼ ▲ </pre>	<pre> CALVAL2 119.50 ✖ </pre>	<ul style="list-style-type: none"> Integer digits flash, set by pressing ▲ ▼ (119) + OK Decimal digits flash, set by pressing ▲ ▼ (50) + OK <p>The second of 3 points is calibrated.</p>
<p>Return to 2. set working temperature value SETPNT: 160.00 °C</p>		
<pre> ATE <I> TMPVAL3 ▼ ▲ </pre>	<pre> TMPVAL3 16000 ↻ </pre>	<p>The value is only indicated.</p>
<pre> ATE <I> CALVAL3 ▼ ▲ </pre>	<pre> CALVAL3 159.30 ✖ </pre>	<ul style="list-style-type: none"> Integer digits flash, set by pressing ▲ ▼ (159) + OK Decimal digits flash, set by pressing ▲ ▼ (30) + OK <p>The 3-point calibration is completed</p>
<p>5. Return to standard operation</p>		
<pre> ATE <I> STATUS OK → </pre>	<pre> STATUS YES ✖ OK </pre>	<ul style="list-style-type: none"> Set >YES< after calibration. (Standard operation)

9.8. MENU LIMITS - Begrenzungen

Menu level 1		
Level 2	Parameter level	Press the key if parameter is to be retained. Correction function for parameters or values (prior to OK).
		<ul style="list-style-type: none"> Integer digits flash, set by pressing + Decimal digits flash, set by pressing +
		<ul style="list-style-type: none"> Integer digits flash, set by pressing + Decimal digits flash, set by pressing +
		<ul style="list-style-type: none"> The value flashes, set by pressing +
		<ul style="list-style-type: none"> The value flashes, set by pressing mit +
In case of external control these menu items are additionally indicated.		
		<ul style="list-style-type: none"> Integer digits flash, set by pressing + Decimal digits flash, set by pressing +
		<ul style="list-style-type: none"> Integer digits flash, set by pressing + Decimal digits flash, set by pressing +
		<ul style="list-style-type: none"> The value flashes, set by pressing +
		<ul style="list-style-type: none"> The value flashes, set by pressing +

9.8.1. Limits for internal control

C-TYPE
INT

SETMAX
300.00

SETMIN
-94.99

SETPOINT MAX / MIN – Maximum and minimum setpoint
Restriction of the adjustable temperature range.

The limitation of the operating temperature range effects the temperature setting in the menu with the key .

Only setting of working temperatures which lie within the determined limits is possible

Existing settings for SETPNT 1, -2, -3, as well as those for >OVERTMP< and > SUBTMP < (refer to page 27), are automatically deferred into the limit range.

Setting range: -94,90 °C ... +300,0 °C

 SET MAX > SET MIN
Interchange of values is not possible.

Set maximum heating / cooling

The heating and cooling capacity of the unit are adjustable. 100 % corresponds to the technical specification of the equipment.

Setting range:

HEAT MAX – 0 to 100 % in 1 % steps

COOLING MAX – 0 to 100 % in 1 % steps

HEATMAX
100

COOLMAX
0

9.8.2. Limits for external control

INTERN MAX / MIN

Restriction for the temperature range of the internal bath.

Setting range: -94,9 °C ... +300,0 °C

The limits INT MAX and INT MIN are only active in external control. INT MAX and INT MIN determine fixed limits for the temperature within the internal bath. The temperature controller cannot exceed these limits even if it would be necessary for achieving the temperature in an external system. Therefore it is possible that the external setpoint cannot be achieved.

Sense of limit setting:

- Protects the bath fluid from overheating.
- Prevents an undesired alarm shutdown by the excess temperature protection - >ALARM CODE 14<.
Set the value of > INT MAX at least 5 °C below the value of >SAFETMP<.
- Protects the pump motor from high viscosity of the bath fluid at low temperatures.
- For refrigerated circulators. Freezing protection when using water as bath fluid.

INTMAX
300.00

INTMIN
-94.99



BAND HIGH / LOW – Band limitation

BAND-H
200

BAND-L
200

The band limitation is active during external control. Varied, practice-oriented settings are feasible for heat-up and cool-down phases.

Setting range: 0 °C ... 200 °C

BAND HIGH and **BAND LOW** allow for the limitation of the difference between the temperatures in the internal bath and the external system to any maximum value for the heat-up and cool-down phase. During the heat-up phase this difference value is always added to the actual external temperature. During the cool-down phase the difference value is subtracted.

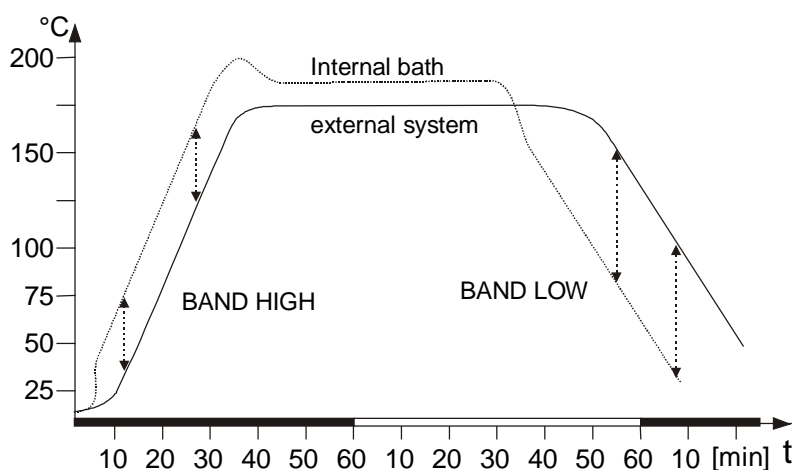

Sense of a band limitation:

- Protection of objects and samples by gentle temperature control
- Protection of e.g. glass reactors from thermal shock.

9.9. MENU IN/OUT – Analog inputs/outputs (Option)

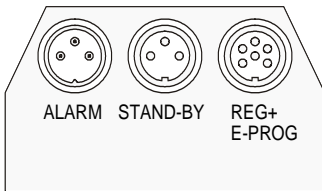

i In order to use the analog inputs and outputs, the circulator must be equipped with the electronic module available as option.
Order No. 8 900 100 Electronic module

This submenu enables setting of the input and output values for the programmer input and the temperature recorder outputs of socket REG+E-PROG.

The >STAND-BY< input and the >ALARM< output are configurable.

Menu level 1



i Press the key if parameter is to be retained. Correction function for parameters or values (prior to OK).

Level 2	Level 3	Parameter level	
			<ul style="list-style-type: none"> The parameter flashes, switch by pressing and <p>ACTINT [°C] internal actual temperature value (bath temperature)</p> <p>ACTEXT [°C] external actual temperature value (external sensor)</p> <p>S-POINT [°C] active setpoint temperature</p> <p>POWER [%]</p>
			<ul style="list-style-type: none"> Integer digits flash, set by pressing +
			<ul style="list-style-type: none"> Decimal digits flash, set by pressing +
			<ul style="list-style-type: none"> The parameter flashes, switch by pressing and

Level 2	Level 3	Parameter level	
	CH2 0V → 	0V °C -99.90 ✖	<ul style="list-style-type: none"> Integer digits flash, set by pressing + Decimal digits flash, set by pressing +
	CH2 10V → 	10V °C 400.00 ✖	
IN/OUT CH3 → 	CH3 OUTPUT → 	OUTPUT SETPNT ✖ OUTPUT ACTINT OUTPUT POWER OUTPUT ACTEXT	<ul style="list-style-type: none"> The parameter flashes, switch by pressing and
	CH3 0mA → 	0mA °C -99.90 ✖	<ul style="list-style-type: none"> Integer digits flash, set by pressing + Decimal digits flash, set by pressing +
	CH3 20mA → 	20mA °C 400.00 ✖	
	CH3 RANGE → 	RANGE 4-20mA ✖ RANGE 0-20mA	<ul style="list-style-type: none"> The parameter flashes, switch by pressing and
IN/OUT EPROG → 	EPROG U INPUT → 	INPUT SETPNT ✖ INPUT ACTVAR INPUT FLOWRAT	<ul style="list-style-type: none"> The parameter flashes, switch by pressing and
	EPROG SIGNAL → 	SIGNAL VOLTAGE ✖ or SIGNAL CURRENT	<ul style="list-style-type: none"> ① The parameter flashes, switch by pressing and ① Define the indication of EPROG U INPUT or EPROG I INPUT VOLTAGE CURRENT

Menu functions

Level 2	Level 3	Parameter level	
	EPROG LVAL ▼ ▲	LVAL °C -9990 Lower VALue	<ul style="list-style-type: none"> Integer digits flash, set by pressing ▲ ▼ + OK Decimal digits flash, set by pressing ▲ ▼ + OK
	EPROG UVAL ▼ ▲	UVAL °C 40000 Upper VALue	
IN/OUT EX-STBY OK → ▼ ▲	EX-STBY INACTIV ✖ or EX-STBY ACTIV		<ul style="list-style-type: none"> The parameter flashes, switch by pressing ▲ ▼ and OK
IN/OUT AL-OUT OK → ▼ ▲	AL-OUT FUNCT ▼ ▲	FUNCT STANDBY ✖ FUNCT AL-STBY FUNCT ALARM	<ul style="list-style-type: none"> The parameter flashes, switch by pressing ▲ ▼ and OK
	AL-OUT TYPE ▼ ▲	TYPE NORMAL ✖ TYPE INVERSE	<ul style="list-style-type: none"> The parameter flashes, switch by pressing ▲ ▼ and OK

9.9.1. Outputs of the connector - REG+E-PROG

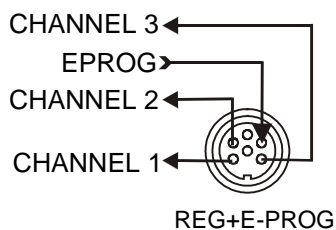

REG+E-PROG :

1. Select CHANNEL 1, 2 or 3
2. First define the desired output value for CHANNELs 1 to 3:

<code>OUTPUT</code>	
<code>ACTINT</code>	internal actual temperature value (bath temperature)
<code>OUTPUT</code>	
<code>ACTEXT</code>	external actual temperature value (external sensor)
<code>OUTPUT</code>	
<code>POWER</code>	periodic or intermittent heating or cooling
<code>OUTPUT</code>	
<code>SETPNT</code>	active setpoint temperature

(SETPoint 1, 2, 3,/ integr. programmer /external programmer)

1. `CH1`
`OUTPUT`

2. `OUTPUT`
`ACTINT`

3. `CH1`
`0V`
`0V` `°C`
`10.00`

`CH1`
`10V`
`10V` `°C`
`2 10.00`

3. Then select the display size for CHANNELs 1 to 3:

Voltage outputs CHANNELs 1 and 2

Assign the voltage values of 0 V to the lowest and 10 V to the highest necessary temperature (°C) or power rating (%) required as an output value.

CHANNEL 3: Output for temperature value (°C) / power (%)

The current output (channel 3) offers 2 ranges for selection:

- 0 mA to 20 mA or
- 4 mA to 20 mA

Assign the current values 0 mA or 4 mA to the lowest and 20 mA to the highest temperature (°C) or power rating (%) required as an output value.

<code>RANGE</code>	<code>CH3</code>	<code>CH3</code>	
<code>0-20mA</code>	<code>0mA</code>	<code>20mA</code>	or
<code>RANGE</code>	<code>CH3</code>	<code>CH3</code>	
<code>4-20mA</code>	<code>4mA</code>	<code>20mA</code>	

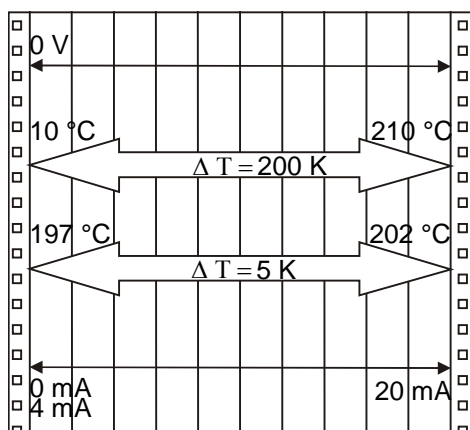

Example 1: `CH1` `OUTPUT`
`OUTPUT` `ACTINT`

`👁` lowest temperature value: 10 °C

`👁` highest temperature value 210 °C

Fig. shows 200 °C scaled to paper width
rise: 50 mV/°C

Example 2:

lowest temperature value: 197 °C

highest temperature value: 202 °C

Fig. shows 5 °C scaled to paper width
rise: 2000 mV/°C

9.9.2. Input of the connector - REG+E-PROG

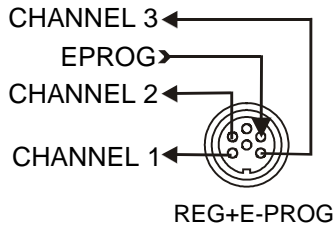

Setting needs to be carried out, if

1. setpoint programming is to be made via an external voltage or current source or programmer.

For this, in the menu > MENU / CONFIG < first set the menu item > SETP < to >EPROG<.

```
MENU    CONFIG    SP EXT
CONFIG > SP EXT > EPROG
```

2. the heater variable should be controlled via an external control pulse. For this, in the menu > MENU / CONFIG < set the menu item >ACTVAR< to >EPROG<.

```
MENU    CONFIG    ACTVAR
CONFIG > ACTVAR > EPROG (refer to page 41).
```

3. the signal of an external flow meter should be registered. >FLOWRAT< see below.

>FLOWRAT<
Indication on display



① FLOWRAT

The E-Prog input can only be used either under menu item >CONFIG -SP EXT< or under menu item >CONFIG ACTVAR<

If the input is neither occupied by > SP EXT < or > ACTVAR <, the signal of a flow meter can be connected.

① First set >MENU CONFIG<

```
MENU    CONFIG    SP EXT
CONFIG > SP EXT > OFF
```

then >MENU IN/OUT<

```
MENU    EPROG U    INPUT
IN/OUT > INPUT > FLOWRAT
```

MENU
IN/OUT



EPROG
SIGNAL

Settings on input - E-PROG

1. Connect the external voltage or current source or programmer to socket REG+E-PROG of the circulator.

2. Selecting the signal:

The programmer (E-PROG) input of the circulator can be matched to the output signal of the external voltage or current source.

```
SIGNAL    EPROG U
VOLTAGE   voltage input = U → INPUT
```

```
SIGNAL    EPROG I
CURRENT   current input = I → INPUT
```

3. Define the input variable:

INPUT
SETPNT Setpoint programmed by external voltage or current

INPUT
ACTVAR Manipulated (ACTuated) variable for the heater
with an external control pulse

INPUT
FLOWRAT Signal of an external flow sensor

Beispiel: EPROG U
INPUT

Examples:

```

LVAL °C
000

```

```

LVAL °C
30000

```

4. EPROG LVAL – Setting the LOW value: (See below ↻)

First adjust and set the lowest voltage or current on the external voltage or current source (e.g. 0 V or 0 mA).

Then after approx. 30 secs enter the corresponding temperature value (e.g. 20.00 °C) on the circulator by pressing

▲ ▼ and OK

5. EPROG LVAL – Setting the HIGH value: (See below ↻)

First adjust and set the highest voltage or current on the external voltage or current source (e.g. 10 V or 20 mA).

Then after approx. 30 secs enter the corresponding temperature value (e.g. 300 °C) on the circulator by pressing

▲ ▼ and OK

```

- OFF -
SP 50.00
I X.X.XX

```

Example:

Set the external voltage or current source output for the equivalent of 50 °C temperature setpoint.

Press ↻ ⌚ - to standard display.

The temperature value adjusted and set on the external voltage or current source is displayed in line 2 of the VFD COMFORT-DISPLAY for control purposes. (Example: SP 50.00 °C).



This EPROG input enables the use of different voltage and current values as program parameters.

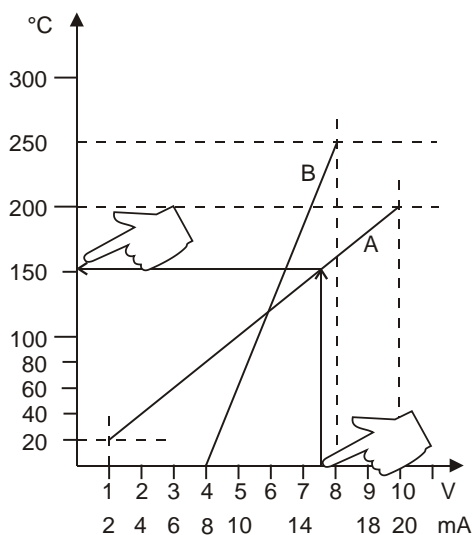

EPROG LVAL – Setting the LOW value: (See below ↻)

1. Adjust and set the lowest desired value on the voltage or current source resp. (Example A: 1 V).
Wait appr. 30 seconds.
2. Assign a lower temperature threshold value to this adjusted voltage/current value by pressing the appropriate buttons on the keypad of the instrument (Example A: 20 °C) and set by pressing OK .

EPROG LVAL – Setting the Upper value: (See below ↻)

1. Adjust and set the highest desired value on the voltage or current source resp. (Example A: 10 V).
Wait appr. 30 seconds.
2. Assign an upper temperature threshold value to this adjusted voltage/current value by pressing the appropriate buttons on the keypad of the instrument (Example A: 200°C) and set by pressing OK .

```

LVAL °C
20.00

```

```

LVAL °C
200.00

```

ⓘ Example B in the diagram serves to illustrate that the end point values are freely selectable (Ex: 8 mA and 16 mA).



Example out of diagram A:

- Adjusting the voltage source for an output of 7.6 V!

The instrument calculates this value from the rise angle of the two predecided end points (in example A: 7.6 V correspond to an external setpoint temperature of 152.0 °C).

After returning the VFD display to standard display, this value is displayed in line 2 (Example: SP 152.00 °C).



Notice:

If this adjustment is not correctly performed at two different points, the setpoint setting will be incorrect.



Important:

The usable temperature range between > **LVAL** < and > **UVAL** < is limited to the configured working temperature range of the circulator resp. of the unit combination (working temperature range see technical specifications)

9.9.3. ALARM-output / Stand-by-input

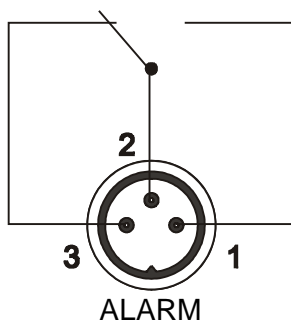

Alarm output (10)

(for external alarm signal)

Possible parameters:



(STANDBY or ALARM or AL-STBY)



This socket is a potential-free change-over contact. With the adjustments in the menu item > **AL-OUT** Function< all operating conditions can be signaled without having to change the pin assignments.

Signification of the terms under menu item >Function< :

The circulator is in condition >STANDBY< or >ALARM< or >AL-STBY< - both conditions are signaled.



Alarm-TYPE

Possible parameters:

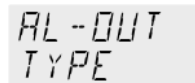

(NORMAL or INVERS)

For >**TYPE- NORMAL**< pins 2 and 3 are connected in any case according to the selected > **AL-OUT** Function<

For >**TYPE- INVERS**< pins 2 and 1 are connected in any case according to the selected > **AL-OUT** Function<

Switching capacity	max.	30 W / 40 VA
Switching voltage	max.	125 V~/-
Switching current	max.	1 A

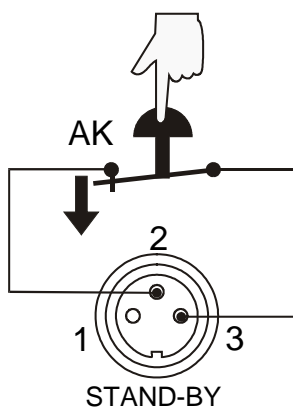

```
EX-STBY
INACTIV
EX-STBY
ACTIV
```

EX-STBY: External Stand-by input (for external switch-off)

Possible parameters:

```
IN/OUT
EX-STBY
```

INACTIV - standby input is ignored

ACTIV - standby input is active

Activate the standby input:

1. Under menu item > EXT-STBY <, set the parameter to >**ACTIV**<.
2. Connect an external contact ,AK' (e.g. for switch-off) or an alarm contact of the superordinated system.

In case the connection between Pin 2 and Pin 3 is interrupted by opening the contact ,AK', a complete shutdown of the circulating pump and heater is effected, and the unit enters the condition „**E OFF**“.

If the contact is reclosed, the instrument returns to the standby state and „**E OFF**“ is displayed. Press **OK** to start.

i Additional tips for using the STANDBY input:

The standby function can be used in conjunction with the AUTOSTART feature

1. If the Autostart function is NOT turned ON, the standby input is used as described above.
2. If the Autostart function is enabled, the instrument will revert back to the original method of entering the setpoint (i.e. keypad, RS232, Analog input, etc.).

Entering the setpoint with the keypad. e.g. **T**

As described above, a bipolar shutdown is accompanied by displaying the „**E OFF**“ state. The circulator starts again when the contact is reclosed. The temperature of the bath fluid changed during the „**E OFF**“ state.

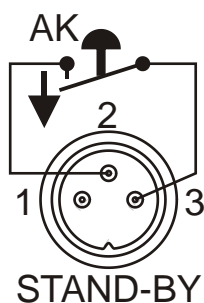

```
E OFF
S XXXX
I XXXX
```

Entering the setpoint with the programmer.

The display **E OFF** appears. The setpoint value and the time are both held at the current value. The temperature of the bath fluid will be held constant at this temperature. The programmer continues once the contact is reclosed.

Notice: This is not an actual shutoff feature.

10. Troubleshooting guide / error messages

-OFF-
ALARM
CODE 01

Alarm with complete shutdown:

If one of the following failures occur a complete, all-pole shutdown of the heater and circulating pump is effected.

„“ lights up and a continuous signal sounds.

The code for the cause of alarm is indicated on the VFD COMFORT-DISPLAY.



00.000
WARNING
CODE 40

Alarm without shutdown:

The code for the cause of alarm is indicated on the VFD COMFORT-DISPLAY. The warning signal sounds in regular intervals. The messages appear every 10 seconds.



Press the key **OK** to stop the signal

ALARM
CODE 01

Error message with ticker: >LOW LEVEL ALARM-FILL MEDIUM <

Low level alarm

The circulator is operated without or insufficient bath fluid.

Switch the unit off with the mains switch, refill bath fluid and switch on!

Tube breakage has occurred (insufficient filling level of bath fluid caused by pumping-out)

Replace the tubing and refill bath liquid.

The float is defect (e.g. transport damage).

Repair by authorized JULABO service personnel.

ALARM
CODE 02

Error message with ticker:

> REFRIGERATOR ALARM-CHECK CONNECTION <

During the self-test after switch-on a short –circuit is detected between pin 2 and pin 4 of the control line or the control line was disconnected during operation.

Reconnect the control line or repair short-circuit.

WARNING
CODE 03

Error message with ticker:

> EXCESS TEMPERATURE WARNING-CHECK LIMITS <

Excess temperature warning

or

Excess temperature alarm

Type of warning: set to >warning< or >alarm< (refer to page 29)

ALARM
CODE 03

WARNING
CODE 04

Error message with ticker:

> LOW TEMPERATURE WARNING-CHECK LIMITS <

Low temperature warning

or

Low temperature alarm.

Type of warning: set to >warning< or >alarm< (refer to page 29)

ALARM
CODE 04

ALARM
CODE 05

Error message with ticker:

> WORKING SENSOR ALARM-CALL SERVICE <

Cable of working temperature sensor is disconnected or short-circuited.

ALARM
CODE 06

Error message with ticker:
>SENSOR DIFFERENCE ALARM-CHECK VISCOSITY AND PUMP STAGE<
Defect of working or excess temperature protector.
Working temperature sensor and excess temperature protector report a temperature difference of more than 35 K.

ALARM
CODE 07

Error message with ticker:
> INTERNAL HARDWARE ERROR-CALL SERVICE <
Other errors

ALARM
CODE 12

Error in A/D converter

ALARM
CODE 14

Error message with ticker:
> EXCESS TEMPERATURE PROTECTOR ALARM-CHECK ADJUSTMENT <
Excess temperature protector defect.
The protection temperature is below the set working temperature setpoint.
Set the protection temperature to a higher value.

ALARM
CODE 15

Error message with ticker:
> EXTERNAL SENSOR ALARM-CHECK EXTERNAL SENSOR <
External control was set but the Pt100 external sensor was not connected or is defect.

ALARM
CODE 33

Error message with ticker:
> SAFETY SENSOR ALARM-CALL SERVICE <
The cable of the excess temperature protector has been disconnected or short-circuited

ALARM
CODE 38

Ext. Pt100 sensor input without signal, but setpoint programming set to external Pt100.

WARNING
CODE 40

Error message with ticker:
> LOW LEVEL WARNING-FILL MEDIUM <
The early warning system for low level reports a critical fluid level. Refill bath fluid.

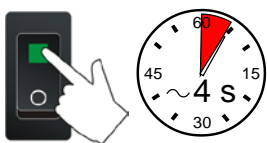

By quickly switching off and restarting the unit the alarm is cancelled.
If the error occurs once more after the restart, a remote diagnosis is required.

C-Err
PRESS
OK

Error message with ticker:
> CONFIGURATION ERROR-PRESS OK<
The configuration of the circulator does not correspond with its current application.
Press the **OK** key for a non-recurring, automatic change of the configuration.
In this case please call the JULABO Technical Service or an authorized dealer.

Disturbances that are not indicated.

The electronic pump motor is overload-protected by an electronic current limiter. If viscosity of the bath fluid is or becomes too high, the motor stops running.



Warning:

Before exchanging the fuses, turn off the mains power switch and disconnect the power plug from the mains socket!
Only use fine fuses with a nominal value as specified.

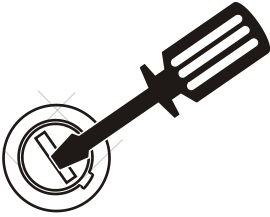

Fuses:

The mains fuses on the rear of the unit may easily be exchanged as shown on the left.
Fine fuses (16)– T 16 A

Example:

Manufacturer	Supplier	Type	Order No.
Schurter	Schurter	G-fuse insert SPT T16A 5x20mm	No. 0001.2516
Wickmann	Wickmann	G- fuse insert T10,0A 5x20 mm	No. 19195

11. Electrical connections



Notice:

Use shielded cables only.

The shield of the connecting cable is electrically connected to the plug housing. The unit ensures safe operation if connecting cables with a maximum length of 3 m are used. The use of longer cables does not affect proper performance of the unit, however external interferences may have a negative impact on safe operation (e.g. cellular phones).

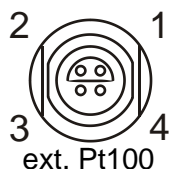

Socket for external Pt100 sensor

Pin assignment:

Pin	Signal
1	I+
2	U+
3	U-
4	I-

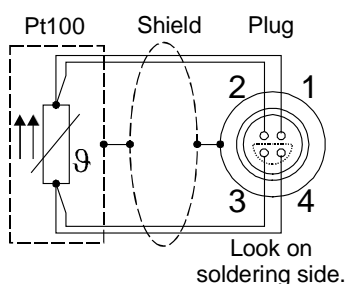

The shield of the connecting cable is electrically connected to the plug housing and the sensor tube.

RS232 serial interface

This port can be used to connect a computer with an RS232 cable for remote control of the circulator.

Pin assignments RS232:

Pin 2	RxD	Receive Data
Pin 3	TxD	Transmit Data
Pin 5	0 V	Signal GND
Pin 7	RTS	Request to send
Pin 8	CTS	Clear to send

Pin 1; 4; 6, 9 Reserved - do not use!

RS232 interface cable

Circulator (9-pol)		PC (9-pol)
Pin 2 RxD	↔	Pin 3 TxD
Pin 3 TxD	↔	Pin 2 RxD
Pin 5 GND	↔	Pin 5 GND
Pin 7 RTS	↔	Pin 8 CTS
Pin 8 CTS	↔	Pin 7 RTS

Accessories:

Order No.

Description

8 980 073	RS232 interface cable 9-pol./9-pol. , 2,5 m
8 900 110	USB interface adapter cable

 / Control output

The connector may only be used for control of a JULABO refrigerated circulator or JULABO MVS Solenoid valve controller for cooling water.

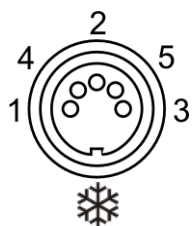

Pin assignment:

Pin	Signal (only with attached JULABO equipment)
1	+24 V (I max. current 25 mA)
2	0 V
3	Alarm relay
4	Reserved - do not use!
5	Cooling pulse

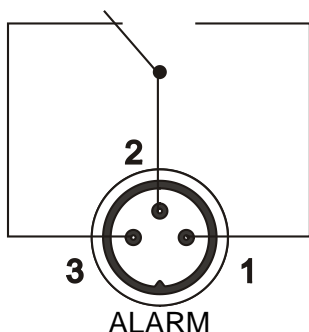

Alarm output

(for external alarm signal)

This potential-free change-over contact is activated in case of an alarm when pins 2 and 3 are connected.

Switching capacity	max. 30 W / 40 VA
Switching voltage	max. 125 V~/–
Switching current	max. 1 A

Functional description see page 64

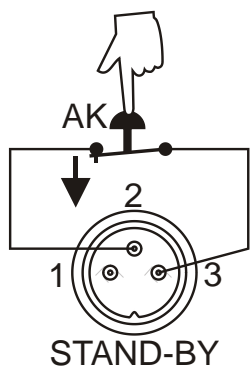

STAND-BY input

(for external emergency switch-off)

Pin assignment:	Pin	Signal
	1	not connected
	2	5 V / DC
	3	0 V

Functional description see page 6

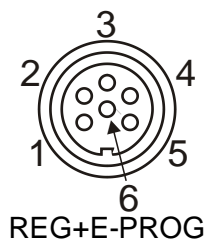

Programmer input / temperature recorder output

Pin	Signal
1 Voltage output	Channel 1 0 ... 10 V
2 Voltage output	Channel 2 0 ... 10 V
3 GND for outputs	0 V
4 Programmer input	EPROG 0 to 10 V / 0 to 20 mA
5 Current output	Channel 3 0 to 20 mA / 4 to 20 mA
6 GND for Programmer	0 V

Functional description see page 61

12. Remote control

12.1. Setup for remote control

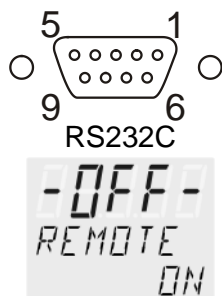

1. Check the interface parameters for both interfaces (on circulator and PC) and make sure they match.
(Serial interface refer to page 48)
2. In the menu > MENU CONFIG < set
the menu item `CONFIG` to `REMOTE`
the menu item `REMOTE` to `ON` .
3. Connect both units with an interface cable..



Like all parameters which can be entered through the keypad, interface parameters are stored in memory even after the circulator is turned off.

12.2. Communication with a PC or a superordinated data system

If the circulator is put into remote control mode via the configuration level, the VFD COMFORT-DISPLAY will read "R -OFF-" = REMOTE STOP. The circulator is now operated via the computer.
In general, the computer (master) sends commands to the circulator (slave). The circulator sends data (including error messages) only when the computer sends a query.



In remote control mode, the start command and all values to be set must be resent by the PC via the interface in case of a power interruption. AUTOSTART is not possible.

A transfer sequence consists of:

- command
- space (↔; Hex: 20)
- parameter (decimal separation with a period)
- end of file (↵; Hex: 0D)

The commands are divided into **in** and **out** commands.

in commands: retrieve parameters

out commands: set parameters

Important times for a command transmission:

To ensure a safe data transfer, the time gap between two commands should be at least 250 ms.

The circulator automatically responds to an **in** command with a data string followed by a LF (Line Feed). The next command should only be sent after 10 ms.

The out commands are valid only in remote control mode.

Command to set the working temperature > SETPNT 1< to 55.5 °C

out_sp_00 ↔ 55.5↵

Command to retrieve the working temperature > SETPNT 1< in_sp_00↵

Response from the circulator: 55.5↵



12.3. List of commands

out commands: Setting temperature values or parameters.

Command	Parameter	Response of circulator
out_mode_01	0	Use working temperature > SETPNT 1<
out_mode_01	1	Use working temperature > SETPNT 2<
out_mode_01	2	Use working temperature > SETPNT 3<
out_mode_02	0	Selftuning „off“. Temperature control by using the stored parameters.
out_mode_02	1	Selftuning „once“ Single selftuning of controlled system after the next start.
out_mode_02	2	Selftuning „always“ Continual selftuning of controlled system whenever a new setpoint is to be reached.
out_mode_03	0	Set external programmer input to voltage. Voltage 0 V ... 10 V
out_mode_03	1	Set external programmer input to current. Current 0 mA ... 20 mA
out_mode_04	0	Temperature control of internal bath.
out_mode_04	1	External control with Pt100 sensor.
out_mode_05	0	Stop the unit = R -OFF-.
out_mode_05	1	Start the unit.
out_mode_08	0	Set the control dynamics - aperiodic
out_mode_08	1	Set the control dynamics - standard
out_sp_00	xxx.xx	Set working temperature. „SETPNT 1“
out_sp_01	xxx.xx	Set working temperature. „SETPNT 2“
out_sp_02	xxx.xx	Set working temperature. „SETPNT 3“
out_sp_03	xxx.xx	Set high temperature warning limit „OverTemp“
out_sp_04	xxx.xx	Set low temperature warning limit „SubTemp“
out_sp_06	xxx.xx	Set manipulated variable for the heater via serial interface -99.99 ... +100 [%]
out_sp_07	x	Set the pump pressure stage. (1 ... 4)
out_par_04	x.x	CoSpeed for external control 0 ... 5.0
out_par_06	xxx	Xp control parameter of the internal controller. 0.1 ... 99.9
out_par_07	xxx	Tn control parameter of the internal controller. 3 ... 9999
out_par_08	xxx	Tv control parameter of the internal controller. 0 ... 999
out_par_09	xxx	Xp control parameter of the cascade controller. 0.1 ... 99.9
out_par_10	xxx	Proportional portion of the cascade controller. 1 ... 99.9
out_par_11	xxx	Tn control parameter of the cascade controller. 3 ... 9999

Command	Parameter	Response of circulator
out_par_12	xxx	Tv control parameter of the cascade controller. 0 ... 999
out_par_13	xxx	Maximum internal temperature of the cascade controller.
out_par_14	xxx	Minimum internal temperature of the cascade controller.
out_par_15	xxx	Band limit (upper) 0 ... 200 °C
out_par_16	xxx	Band limit (lower) 0 ... 200 °C
out_hil_00	-xxx	Set the desired maximum cooling power (0 % to 100 %). Note: Enter the value with a preceding negative sign! This adjustment only makes sense if FP refrigerating units are used.
out_hil_01	xxx	Set the desired maximum heating power (10 % to 100 %).

in commands: Asking for parameters or temperature values to be displayed.

Command	Parameter	Response of circulator
version	none	Number of software version (V X.xx)
status	none	Status message, error message (see page 75)
in_pv_00	none	Actual bath temperature.
in_pv_01	none	Heating power being used (%).
in_pv_02	none	Temperature value registered by the external Pt100 sensor.
in_pv_03	none	Temperature value registered by the safety sensor.
in_pv_04	none	Setpoint temperature of the excess temperature protection
in_sp_00	none	Working temperature „SETP 1“
in_sp_01	none	Working temperature „SETP 2“
in_sp_02	none	Working temperature „SETP 3“
in_sp_03	none	High temperature warning limit „OverTemp“
in_sp_04	none	Low temperature warning limit „SubTemp“
in_sp_05	none	Setpoint temperature of the external programmer (REG+E-PROG) .
in_sp_07	none	1. Adjusted pump stage in the -OFF- condition. 2. Pump stage corresponding to the effective rotation speed after start.
in_sp_08	none	Value of a flowrate sensor connected to the E-Prog input
in_par_00	none	Temperature difference between working sensor and safety sensor
in_par_01	none	Te - Time constant of the external bath.
in_par_02	none	Si - Internal slope
in_par_03	none	Ti - Time constant of the internal bath.

Remote control

Command	Parameter	Response of circulator
in_par_04	none	CoSpeed - Band limit (max. difference between the temperatures in the internal bath and external system).
in_par_05	none	Factor pk/ph0: Ratio of max. cooling capacity versus max. heating capacity
in_par_06	none	Xp control parameter of the internal controller.
in_par_07	none	Tn control parameter of the internal controller.
in_par_08	none	Tv control parameter of the internal controller.
in_par_09	none	Xp control parameter of the cascade controller.
in_par_10	none	Proportional portion of the cascade controller.
in_par_11	none	Tn control parameter of the cascade controller.
in_par_12	none	Tv control parameter of the cascade controller.
in_par_13	none	Adjusted maximum internal temperature of the cascade controller.
in_par_14	none	Adjusted minimum internal temperature of the cascade controller.
in_par_15	none	Band limit (upper)
in_par_16	none	Band limit (lower)
in_mode_01	none	Selected setpoint: 0 = SETP 1 1 = SETP 2 2 = SETP 3 3 = Last setpoint setting was carried out through an external programmer
in_mode_02	none	Selftuning type: 0 = Selftuning „off“ 1 = Selftuning „once“ 2 = Selftuning „always“
in_mode_03	none	Type of the external programmer input: 0 = Voltage 0 V to 10 V 1 = Current 0 mA to 20 mA
in_mode_04	none	Internal/external temperature control: 0 = Temperature control with internal sensor. 1 = Temperature control with external Pt100 sensor.
in_mode_05	none	Circulator in Stop/Start condition: 0 = Stop 1 = Start
in_mode_08	none	Adjusted control dynamics 0 = aperiodic 1 = standard
in_hil_00	none	Max. cooling power (%).
in_hil_01	none	Max. heating power (%).

12.4. Status messages

Status messages	Description
00 MANUAL STOP	Circulator in „OFF“ state.
01 MANUAL START	Circulator in keypad control mode.
02 REMOTE STOP	Circulator in „r OFF“ state.
03 REMOTE START	Circulator in remote control mode.

12.5. Error messages

Error messages	Description
-01 LOW LEVEL ALARM	Low liquid level alarm.
-02 REFRIGERATOR ALARM	Control cable of the refrigerated circulator or MVS solenoid valve controller short-circuited or interrupted.
-03 EXCESS TEMPERATURE WARNING	High temperature warning.
-04 LOW TEMPERATURE WARNING	Low temperature warning.
-05 WORKING SENSOR ALARM	Working temperature sensor short-circuited or interrupted.
-06 SENSOR DIFFERENCE ALARM	Sensor difference alarm. Working temperature and safety sensors report a temperature difference of more than 35 K
-07 I²C-BUS ERROR	Internal error when reading or writing the I ² C bus.
-08 INVALID COMMAND	Invalid command.
-09 COMMAND NOT ALLOWED IN CURRENT OPERATING MODE	Invalid command in current operating mode.
-10 VALUE TOO SMALL	Entered value too small.
-11 VALUE TOO LARGE	Entered value too large.
-12 TEMPERATURE MEASUREMENT ALARM	Error in A/D converter.
-13 WARNING : VALUE EXCEEDS TEMPERATURE LIMITS	Value lies outside the adjusted range for the high and low temperature warning limits. But value is stored.
-14 EXCESS TEMPERATURE PROTECTOR ALARM	Excess temperature protector alarm 
-15 EXTERNAL SENSOR ALARM	External control selected, but external Pt100 sensor not connected.
-20 WARNING: CLEAN CONDENSOR OR CHECK COOLING WATER CIRCUIT OF REFRIGERATOR	Cooling of the condenser is affected. Clean air-cooled condenser. Check the flow rate and cooling water temperature on water-cooled condenser.
-21 WARNING: COMPRESSOR STAGE 1 DOES NOT WORK	Compressor stage 1 does not work.
-22 WARNING: COMPRESSOR STAGE 2 DOES NOT WORK	Compressor stage 2 does not work.

Error messages	Description
-23 WARNING: HIGH TEMPERATURE ON COMPRESSOR STAGE 1	Excess temperature on compressor stage 1.
-24 WARNING: HIGH TEMPERATURE ON COMPRESSOR STAGE 2	Excess temperature on compressor stage 2.
-25 REFRIGERATOR WARNING	Error in the cooling machine.
-26 WARNING: STAND-BY PLUG IS MISSING	External standby contact is open. (see page 64 and 70)
-30 CONFIGURATION ERROR: CONFIRM BY PRESSING <OK> ON CIRCULATOR	The configuration of the circulator does not conform to its present use. Press >OK< to automatically perform a single modification of the configuration.
-33 SAFETY SENSOR ALARM	Excess temperature sensor short-circuited or interrupted.
-38 EXTERNAL SENSOR SETPOINT PROGRAMMING ALARM	Ext. Pt100 sensor input without signal and setpoint programming set to external Pt100.
-40 NIVEAU LEVEL WARNUNG	Low liquid level warning in the internal reservoir.

13. Installation of electronic module



Caution:

Always turn off the unit and disconnect the mains cable from the power source before performing any service or maintenance procedures, or before moving the unit. Configuration, installation, maintenance and repairs on the circulator may only be carried out by qualified personnel.

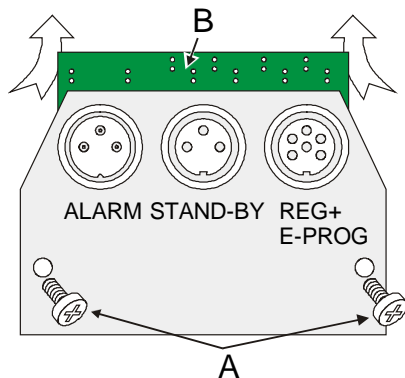

- Turn off the unit with the mains switch and disconnect the power plug.
- Open the screws (A) and remove the dummy plate.
- Carefully insert the upper edge (B) into the rear panel from below, align the electronic module at top and bottom and applying light pressure connect the 15-pole connector.
- Attach the electronic module using the screws (A).
- The circulator is ready for use. It automatically recognizes the installed electronic module.

14. JULABO Service – Online remote diagnosis

JULABO circulators of the HighTech series are equipped with a black box. This box is implemented in the controller and records all significant data for the last 30 minutes.

In case of a failure, this data can be read out from the unit by using special software. This software is available as a **free** download from www.julabo.de \ EasyBlackBox.

- Installation is easy and is performed step by step. Please observe the instructions.
- Data read-out is possible in the conditions “OFF”, “R OFF” or “ALARM”.
- Connect the circulator to the computer using an interface cable.
- Start the EasyBlackBox program.
The program asks for the port used (COM1,) and the baud rate of the unit.
You do not have this information on hand? Simply try it out!
The program continues to send the request until the correct settings are made.

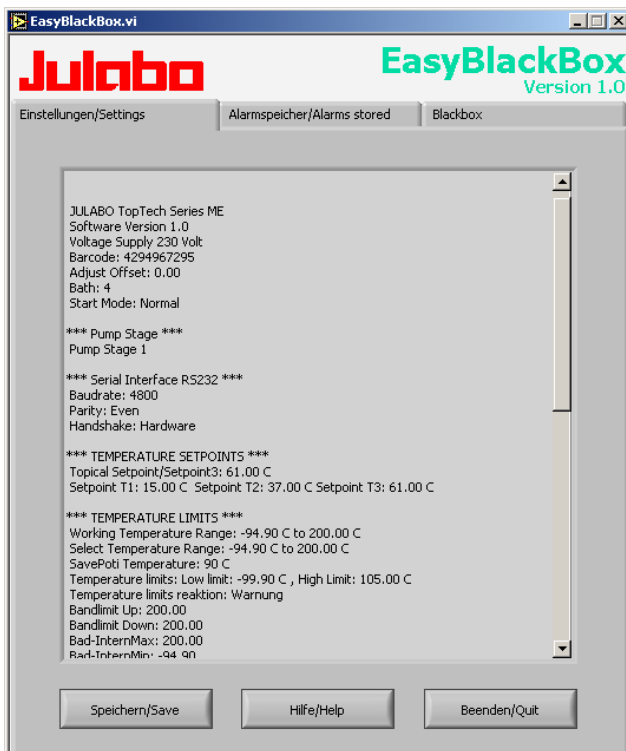

- Data is read out and shown on the monitor divided into the sections
>Einstellungen/Settings<,
>Alarmspeicher/Alarms stored<,
>Blackbox<

← see example
- After pressing >Speichern/Save<, a text file is created. The program suggests a filename - >C:\model description and barcode no.<. Modifications are possible.
- E-mail this file to service@julabo.de, JULABO's service department. JULABO is thus able to provide rapid support.

15. Cleaning / repairing the unit



Caution:

- Always turn off the unit and disconnect the mains cable from the power source before cleaning the unit.
- Prevent humidity from entering into the circulator.
- Electrical connections and any other work must be performed by qualified personnel only.

Cleaning:

For cleaning the bath tank and the immersed parts of the circulator, use low surface tension water (e.g., soap suds).

Clean the outside of the unit using a wet cloth and low surface tension water.

The circulator is designed for continuous operation under normal conditions. Periodic maintenance is not required.

The tank should be filled only with a bath fluid recommended by JULABO. To avoid contamination, it is essential to change the bath fluid from time to time.

Repairs

Before asking for a service technician or returning a JULABO instrument for repair, please contact an authorized JULABO service station.

When returning the unit:

- Clean the unit in order to avoid any harm to the service personnel.
- Attach a short fault description.
- During transport the unit has to stand upright. Mark the packing correspondingly.
- When returning a unit, take care of careful and adequate packing.
- JULABO is not responsible for damages that might occur from insufficient packing.



JULABO reserves the right to carry out technical modifications with repairs for providing improved performance of a unit.